

CALIBRATE COMMUNITY™

February 2021 Price List

AIS

PRODUCT INFORMATION

Calibrate Community Statement of Line 4
 Calibrate Community Finish Options 7
 Calibrate Community Product Details 9
 Calibrate Community Typicals 19

SPINES

Non-Powered Spines 32
 Single Sided Powered Spines 33
 Double Sided Powered Spines 34

END PANELS

Top Mount End Panels and Shared Top Mount End Panels 35
 Mid Mount End Panels 36
 Shared Mid Mount End Panels 37
 Offset Shared End Panels. 39
 Mid Supports and Infeed Base Supports 40

RUN-OFFS

Fixed Run-Offs 41
 Sliding Run-Offs. 42
 Sliding Run-Off Tracks 43
 Fixed Spine Surfaces 44
 Cantilevered Spine Surfaces 45
 Stack-On Desks. 46

SINGLE SIDED SPINE STACK-ON STORAGE

Spine Hutch F. 47
 Spine Hutch G 49
 Spine Hutch J. 52

DOUBLE SIDED SPINE STACK-ON STORAGE

Spine Hutch A. 53
 Spine Hutch B. 55
 Spine Hutch C 57
 Spine Hutch D. 60
 Spine Hutch E. 62
 Spine Hutch H 63
 Spine Hutch K. 64
 Spine Cabinet L. 65
 Spine Cabinet M 66

STORAGE

13" High Floor Storage 68
 21" High BF Pedestals 69
 21" High Hidden Drawer BF Pedestals 70
 21" High Lateral Floor Storage 71
 21" High Floor Bookcases 72
 21" High Shared Floor Bookcases 73
 21" High Floor Cabinets 74
 21" High Floor Credenzas. 75
 21" High Combo Units with BF Pedestal and Bookcase 76

ELECTRICAL AND DATA

Electrical Jumpers 77
 Outlets 78
 Data Plate Kits 79
 Infeeds for Infeed Base Supports. 80

ACCESSORIES

Tackboards for Spine Hutch A 81

Tackboards for Spine Hutch B 83

Tackboards for Spine Hutch C 85

Tackboards for Spine Hutch D 86

Tackboards for Spine Hutch E 87

Tackboards for Spine Hutch G 88

Tackboards for Spine Hutch H (Cantilevered). 89

Tackboards for Spine Hutch H (Full Panel) 90

Tackboards for Spine Hutch J 91

Tackboards for Spine Hutch K 92

SPINES

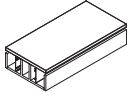

Non-Powered Spine
24 - 36 Wide x 18 - 36 Deep

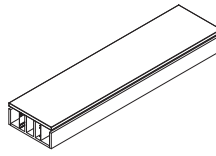

Single Sided Powered Spine
36 - 96 Wide x 18 - 36 Deep

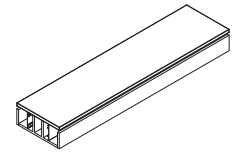

Double Sided Powered Spine
36 - 96 Wide, 18 - 36 Deep

END PANELS

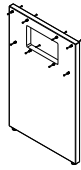

Top Mount End and Shared Panels
18 - 36 Deep, 29 - 46 High
Shared Shown on Right

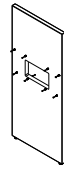

Mid Mount End and Shared Panels
18 - 36 Deep, 29 - 66 High
Shared Shown on Right



Offset Shared End Panels
18 - 36 Deep, 29 - 46 High
Front Shown on Left, Back Shown on Right

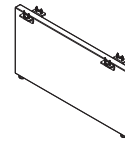

Mid Support
18 - 36 Deep, 13 or 29 High
For use with 21 or 29 High Spines

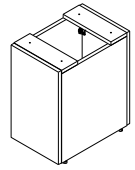

Infeed Base Support
18 - 36 Deep, 6 or 12 Wide, 13 or 21 High
For use with 21 or 29 High Spines

RUN-OFFS

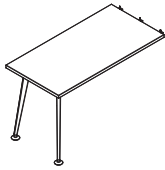

Fixed Run-Off
2mm or Knife Edge
On Glides
2mm Edge on Glides Shown



Sliding Run-Off
2mm or Knife Edge
On Glides or Casters
2mm Edge on Glides Shown

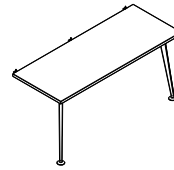

Fixed Spine Surface
2mm or Knife Edge
On Glides
2mm Edge on Glides Shown

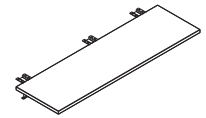

Cantilever Spine Surface
2mm or Knife Edge
2mm Edge Shown

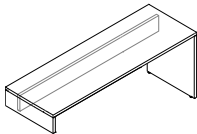

Stack-On Desk
Left, Right or Centered Modesty
Right Modesty Stack-On Desk Shown



Sliding Run-Off Track

SINGLE SIDED SPINE STACK-ON STORAGE

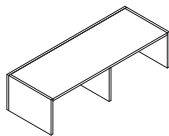

Spine Hutch F
Full Finished Back
12 - 36 High, 24 - 72 Wide, 18 or 24 Deep

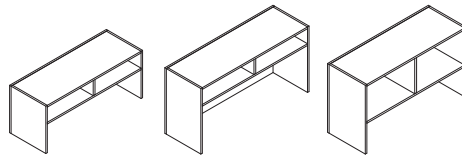

Spine Hutch G
Full Finished Back
20 - 36 High, 24 - 84 Wide, 18 or 24 Deep
20 High with 8 High Cubby Shelf, 28 High with 8 or 16 High Cubby Shelf,
36 High with 16 High Cubby Shelf

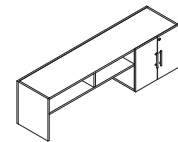

Spine Hutch J
Full Finished Back
20, 28 and 36 High, 60 - 84 Wide, 18 or 24 Deep
8H Cubby Shelf on 20 or 28H, 16H Cubby Shelf on 36H
Left or Right Cabinet
Cabinet Right Shown

DOUBLE SIDED SPINE STACK-ON STORAGE

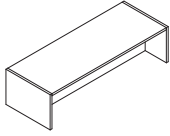

Spine Hutch A
12 - 36 High, 24 - 72 Wide, 18 or 24 Deep

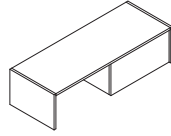

Spine Hutch B
12 - 36 High, 36 - 72 Wide, 18 or 24 Deep
Open Left or Open Right
Open Left Shown

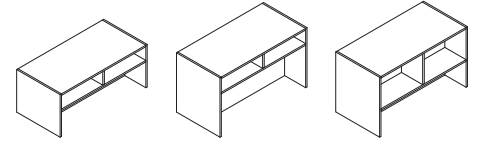

Spine Hutch C
20 - 36 High, 24 - 84 Wide, 24 or 30 Deep
20 High with 8 High Cubby Shelf, 28 High with 8 or 16 High Cubby Shelf,
36 High with 16 High Cubby Shelf

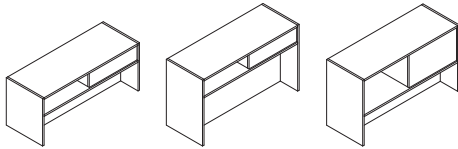

Spine Hutch D
20 - 36 High, 36 - 84 Wide, 18 Deep
20 High with 8 High Cubby Shelf, 28 High with 8 or 16 High Cubby Shelf,
36 High with 16 High Cubby Shelf
Open Left or Open Right
Open Left Shown

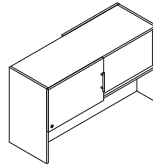

Spine Hutch E
28 and 36 High, 36 - 84 Wide, 18 or 24 Deep
With Sliding Door Cabinet
Door Left or Door Right
Door Left Shown

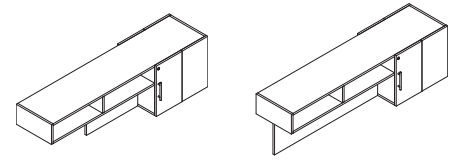

Spine Hutch H
20, 28 or 36 High, 60 - 84 Wide, 18 or 24 Deep
With Yin-Yang Cabinet
Cantilevered or Full Panel
Left: Cantilevered Shown, Right: Full Panel Shown

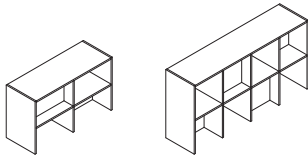

Spine Hutch K
28 or 36 High, 36 - 84 Wide, 18 or 24 Deep
Left: 28H x 48W Shown, Right: 37H x 72W Shown

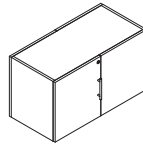

Spine Cabinet L
20, 28 or 36 High, 24 - 48 Wide, 18 or 24 Deep
With Yin-Yang Cabinet
Door Left or Door Right
Door Left Shown

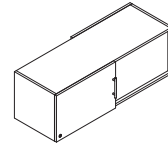

Spine Cabinet M
16 - 36 High, 36 - 84 Wide, 18 or 24 Deep
Door Left or Door Right
Door Left Shown

13 HIGH FLOOR STORAGE (FOR 21 HIGH SPINES)

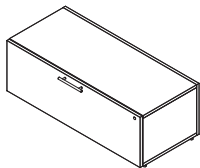

13" High Storage with Single Bottom Box Drawer
15 - 42 Widths, 18 or 24 Depths
18 Depth, 42 Width on Glides Shown
Note: No Filing Capabilities

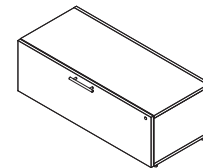

13" High Storage with Bottom and Hidden Top Box Drawer
15 - 42 Widths, 18 or 24 Depths
18 Depth, 42 Width on Glides Shown
Note: No Filing Capabilities

21 HIGH FLOOR STORAGE (FOR 29 HIGH SPINES)

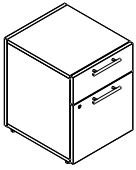

BF Pedestal
12,16 or 18 Widths, 18, 22 or 24 Depths
On Glides or Feet
18 Depth Pedestal on Glides Shown

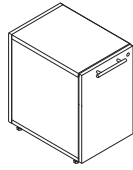

Hidden Drawer BF Pedestal
12,16 or 18 Widths, 18, 23 or 24 Depths
On Glides or Feet
18 Depth Pedestal on Glides Shown

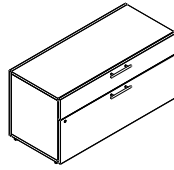

BF Lateral
24 - 42 Widths, 18, 22 or 24 Depths
On Glides or Feet
18 Depth, 42 Width on Glides Shown

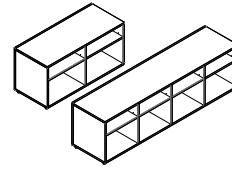

Floor Bookcase
24 - 72 Widths
On Glides or Feet
42 and 72 Widths on Glides Shown

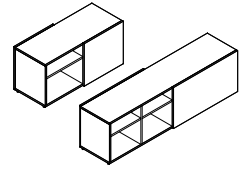

Shared Floor Bookcase
Left or Right Hand, 36 - 72 Widths, 18
Deep, On Glides or Feet
Left Hand 42 and 72 Widths on
Glides Shown

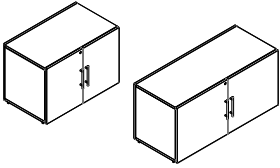

Two Door Cabinet
24 - 48 Widths, 18 Deep
On Glides or Feet
30 and 42 Widths on Glides Shown

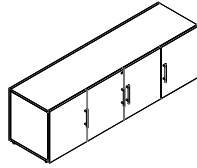

Four Door Cabinet
54 - 72 Widths, 18 Deep
On Glides or Feet
72 Width on Glides Shown

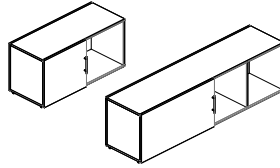

Credenza w/ Sliding Doors
Left or Right Side Lock
36 - 72 Widths, 18 Deep, On Glides or Feet
Left Side Lock in 42 and 72 Widths on
Glides Shown

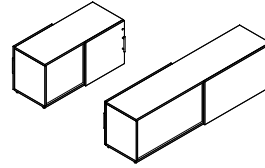

Shared Credenza w/ Sliding Doors
Left or Right Side Lock
36 - 72 Widths, 18 Deep, On Glides or Feet
Right Side Lock in 42 and 72 Widths on
Glides Shown

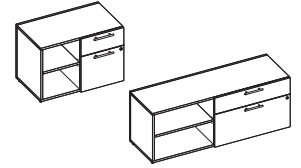

**Combo Unit w/
BF Pedestal and Bookcase**
30 - 72 Widths, 18 or 24 Depths
On Glides or Feet, Bookcase Left or Right
Bookcase Left 36 and 54 Deep on
Glides Shown

ELECTRICAL AND DATA



Electrical Jumper

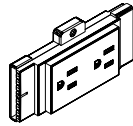

Duplex Outlet

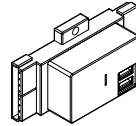

USB Outlet

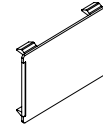

Duplex Outlet Cover

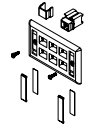

Data Plate Kits

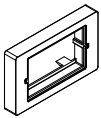

Single Gang Plate Adapter

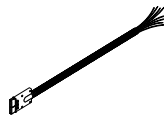

Ceiling Infeed

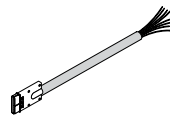

Side-Mounted Base
Infeed



End Mount Poles
For 21 or 29 High

ACCESSORIES

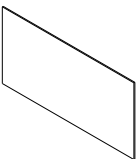

Tackboard for Spine Hutch A
PET or Fabric

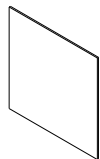

Tackboard for Spine Hutch B
PET or Fabric

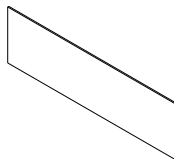

Tackboard for Spine Hutch C
PET or Fabric

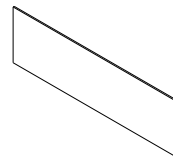

Tackboard for Spine Hutch D
PET or Fabric

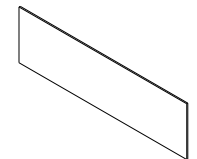

Tackboard for Spine Hutch E
PET or Fabric

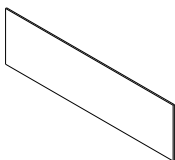

Tackboard for Spine Hutch G
PET or Fabric

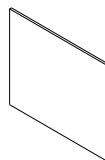

Tackboard for Spine Hutch H
For Cantilevered or Full Panel
PET or Fabric

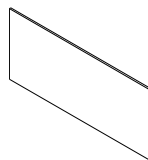

Tackboard for Spine Hutch J
PET or Fabric

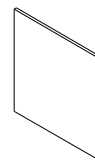

Tackboard for Spine Hutch K
PET or Fabric

Tackboard Fabric Options

TACKBOARD FABRICS BY AIS

Name	Style Number	Grade
Avenue Dusk	2062	A
Avenue Park Place	2064	A
Cape Cod Chatham	2711	A
Cape Cod Falmouth	2712	A
Cape Cod Harwich	2713	A
Cape Cod Hyannis	2714	A
Cape Cod Martha's Vineyard	2715	A
Cape Cod Nantucket	2716	A
Cape Cod Provincetown	2717	A
Engage Denim	2066	A
Engage Neutral	2065	A
Engage Rain Cloud	2067	A
Engage Toffee	2068	A
Mirador Bahamas	3A-33	A
Mirador Lake Blue	3A-34	A
Mirador Light Green	3A-37	A
Mirador Midnight Black	3A-18	A
Mirador Navy Blue	3A-19	A
Mirador Neutral	3A-45	A
Mirador Pacific	3A-28	A
Mirador Stone	3A-6	A
Mirador Storm	3A-54	A
Mirador Red	3A-43	A
Mirador Rusty	3A-51	A
Rainfall Bliss	2059	A
Rainfall Shore	2060	A
Rainfall Sundown	2057	A
Rainfall Twilight	2058	A
Simplicity Blue Smooth	2001	A
Simplicity Chamoise	2002	A
Simplicity Grey Blue	2004	A
Simplicity Sandy Pebble	2005	A
Simplicity Stone	2530	A
Simplicity Twizzle Tan	2008	A
Stream Light Sand	2501	A

TACKBOARD FABRICS BY GUILFORD OF MAINE

Name	Style Number	Grade
Anchorage	2335	B
Bailey	2299	B
Drift	2539	B
Lido	2858	B
Mingle	2527	B
Spinel	3582	B
Sprite	2671	B
Streetwise	2721	B
Reeds	3078	B
Tweed	2737	B
Bix	3008	C
Broadcast	2758	C
Coastline	3495	C
Crosstown	2526	C
Fr701	2100	C
Auster	2537	D
Block Party	2538	D
Groove	3497	D
Lily Pad	2318	D
Network	4158	D
Nitro	2317	D
Phone Tag	2314	D
Regatta	2400	D
Tempest	2120	D
Cosmos	2655	E

Note: 66" & 72" wide screens – if applying directional fabrics they will need to be railroaded for application. If using a COM fabric that is 54" wide, any screen over 48" wide would need to have the fabric railroaded as well.

C.O.M. Fabric Policy

- It is mandatory that you work directly with your AIS Customer Service Representative for all COM related testing and orders. They will provide all necessary forms to you, as well as work with you with regard to sending in correct yardage and where to send it, along with necessary RA# or #s. Please note an RA must be submitted along with the fabric for testing, as well as an RA created for an actual order.
- **Please Note:** A three to five yard sample is required for testing and approval for use on all monolithic panel systems. A one yard sample is required for testing and approval on Divi Insert Tiles, Matrix Tiles, flipper doors and tackboards. We may be able to test upholstery fabrics with a swatch, your Customer Service Representative will advise based on the fabric being tested; otherwise a 1 yard sample must be submitted for testing. Results take 48 - 72 hours.
- Customer Service must be advised as to the width of the fabric rolls being supplied (54"W or 60"W). Customer Service must also be advised if the fabric has a backer.
- Yardage required for the job must be calculated by an AIS Customer Service Rep.
- Once AIS has approved the COM fabric, a fabric sample needs to be marked by the dealer with "Front", "Top", and "Bottom", to be sure fabric is applied correctly. The fabric sample then needs to be attached to a COM Fabric Dealer Form and forwarded to AIS Customer Service. [The COM Fabric Dealer Form may be downloaded or printed here.](#)
- Fabrics may be discontinued or obsolete without notice.
- Contact AIS Customer Service with any questions regarding fabric availability.
- All directional fabric will be railroaded.

Laminate and Paint Options

PAINT OPTIONS		
Name	Color Code	Grade
Black*	BK	A
Chalk	CK	A
Dark Tone	DT	A
Grey Value 1	GV1	A
Innertone	HT	A
Light Tone	LT	A
Medium Tone	MT	A
Metallic Silver	MS	A
Satin White*	SW	A
Warm Brown	WB	A
Champagne Metallic	CHM	B
Dark Grey Metallic	DGM	B
Flint Grey Metallic	FGM	B
Light Grey	LG	B
Tan Value 1	TV1	B
Warm White	WW	B
Woodrose	WR	B
Antique Gold	AG	C
Blue	BL	C
Graphite Sky	GS	C
Lite Silver Smooth	LS	C
Orange	OR	C
Red	RD	C
Violet	VT	C
Yellow	YW	C

LAMINATE OPTIONS	
Name	Grade
Absolute Acajou †	A
Aimtoo Savatre	A
Black	A
Brazilwood	A
Cabinet Almond	A
Chalk	A
Corporate Walnut	A
Dark Rum Cherry	A
Grand Cherry	A
Leave Likatre †	A
Linen	A
Looks Likatre †	A
Maritime Dune †	A
Midwest Maple	A
Nightfall	A
Recon Oak	A
Storm	A
Summer Drops	A
True White	A
Trytoo Savatre †	A
White Chocolate†	A

Laminate options apply to worksurfaces, body/case, desk shell bases, modesties and doors/drawers. Matching edgeband available for all Calibrate laminate options.
 † Indicates a textured laminate with a finish similar to a natural wood grain.

Custom Paints

- Extended lead-time will apply.
- Any color not shown on Quick Ship, Standard Grade A or Grade B will be considered custom.
- A \$450 net paint match fee will be assessed following receipt of (2) 5"x5" samples of paint being matched. Additionally, Grade B paint-charges will be applied to all applicable products on the order.
- **Important Note:** Most paint match pricing can be covered by the Grade B up-charge in the catalog, however the final pricing can only be determined after the paint is matched and a product list is provided to AIS customer service. An additional fee may apply based on job size and paint color.

Community Spine Dimensions

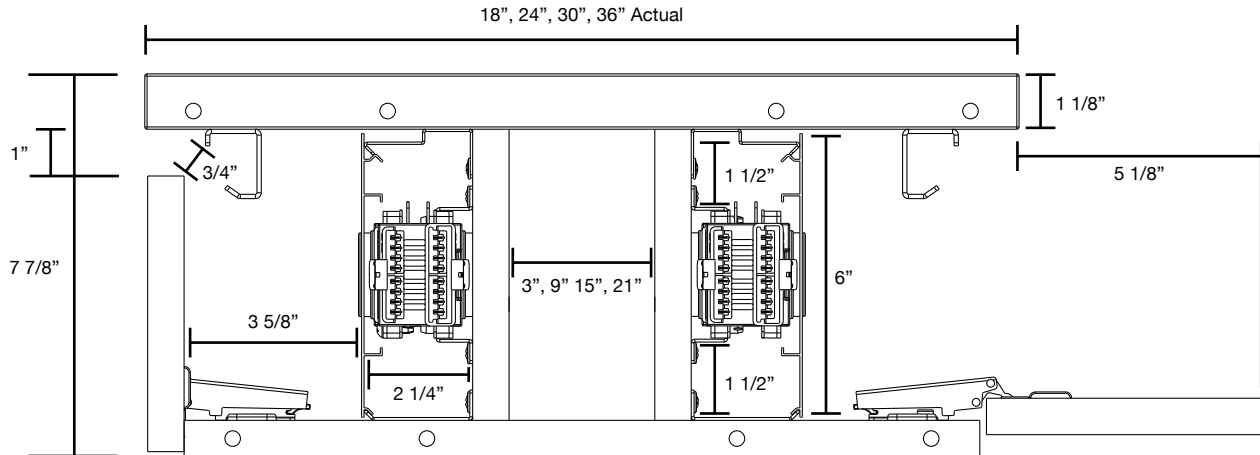

Community Spine Internal Components

- 1. Duplex Outlet
 - 2. Internal cover (metal)
 - 3. Data cable cavity
 - 4. Electrical cable cavity
 - 5. Front to back power jumper*
 - 6. Powerway
 - 7. Sliding surface track (optional)
 - 8. Egress for power cords
 - 9. Flip down door
- *Included on Double Sided Powered Spines.

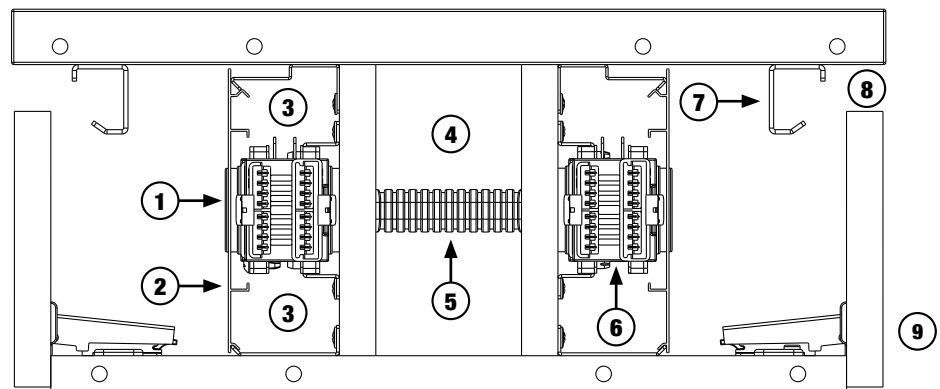

Calibrate Community Product Details

Community Spine External Dimensions and Components

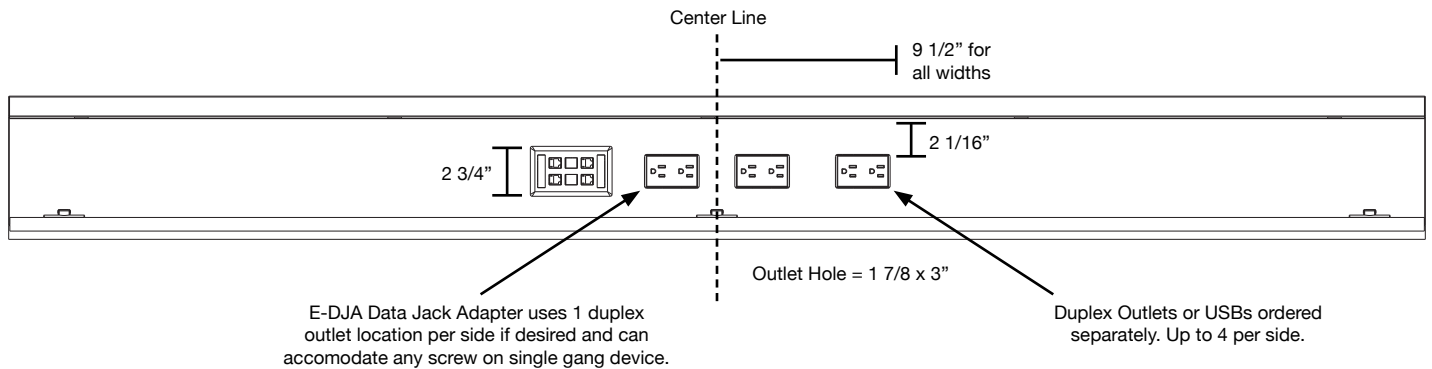
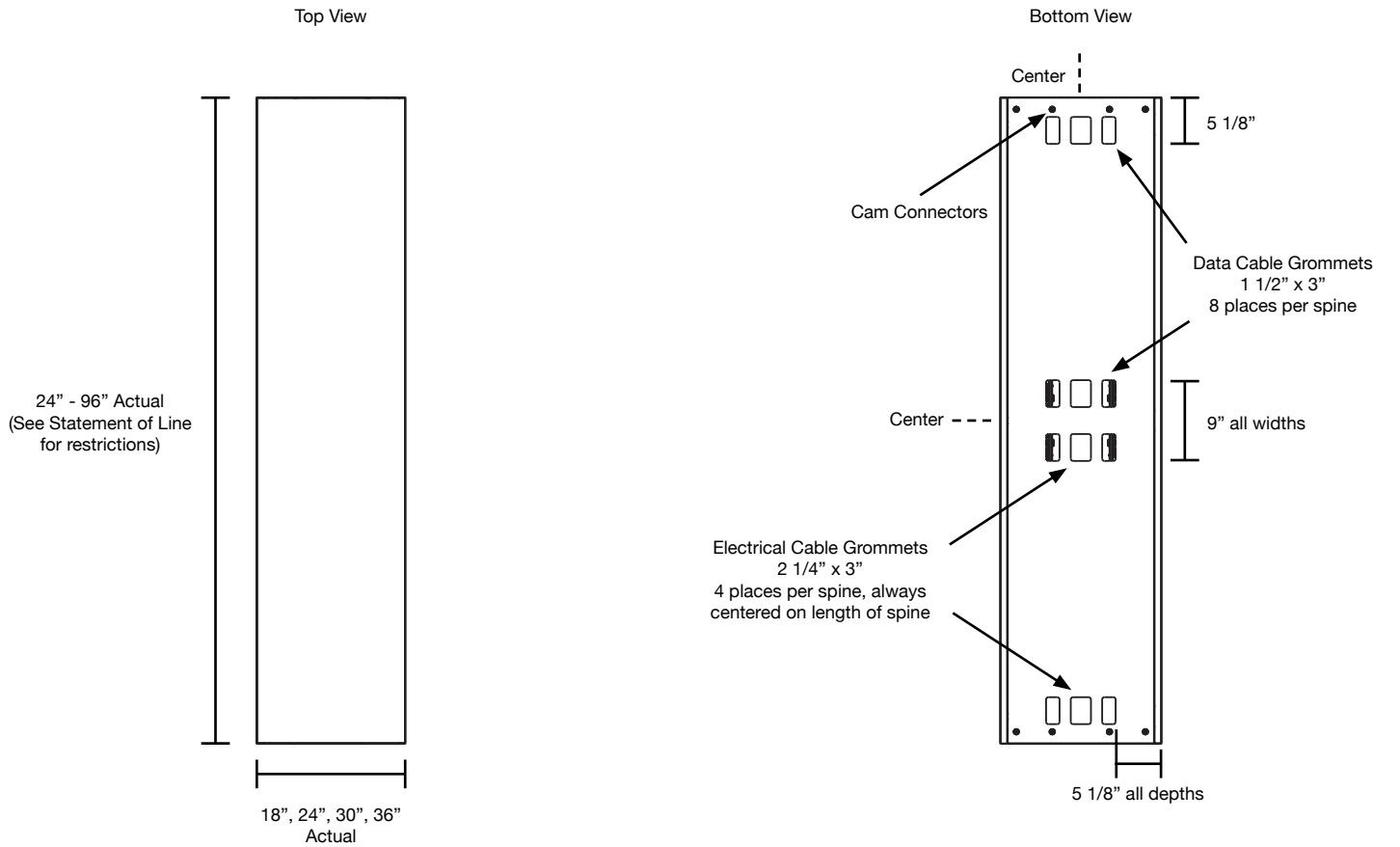

Community Spine Electrical

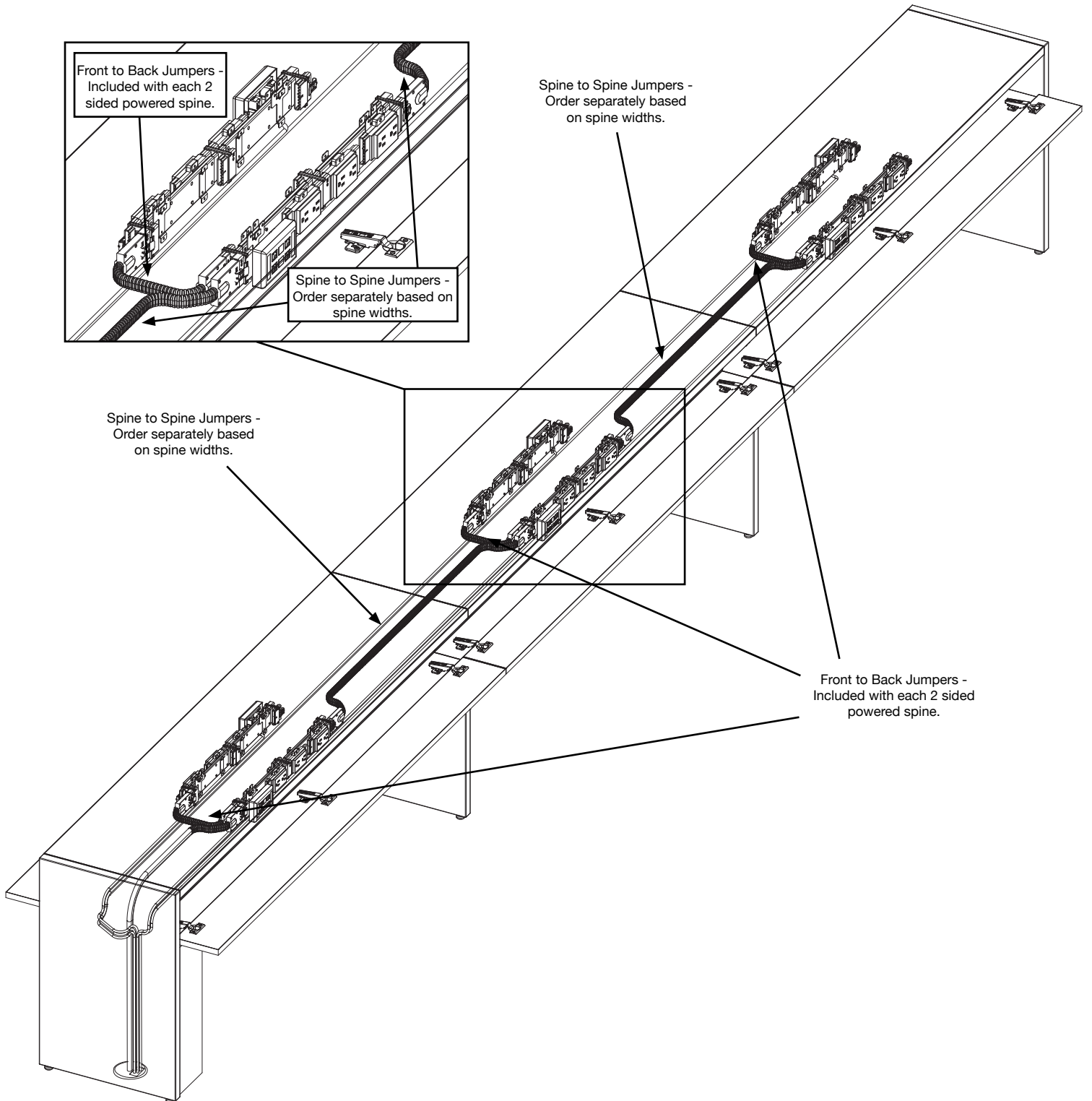

Calibrate Community Product Details

Community Spine Electrical

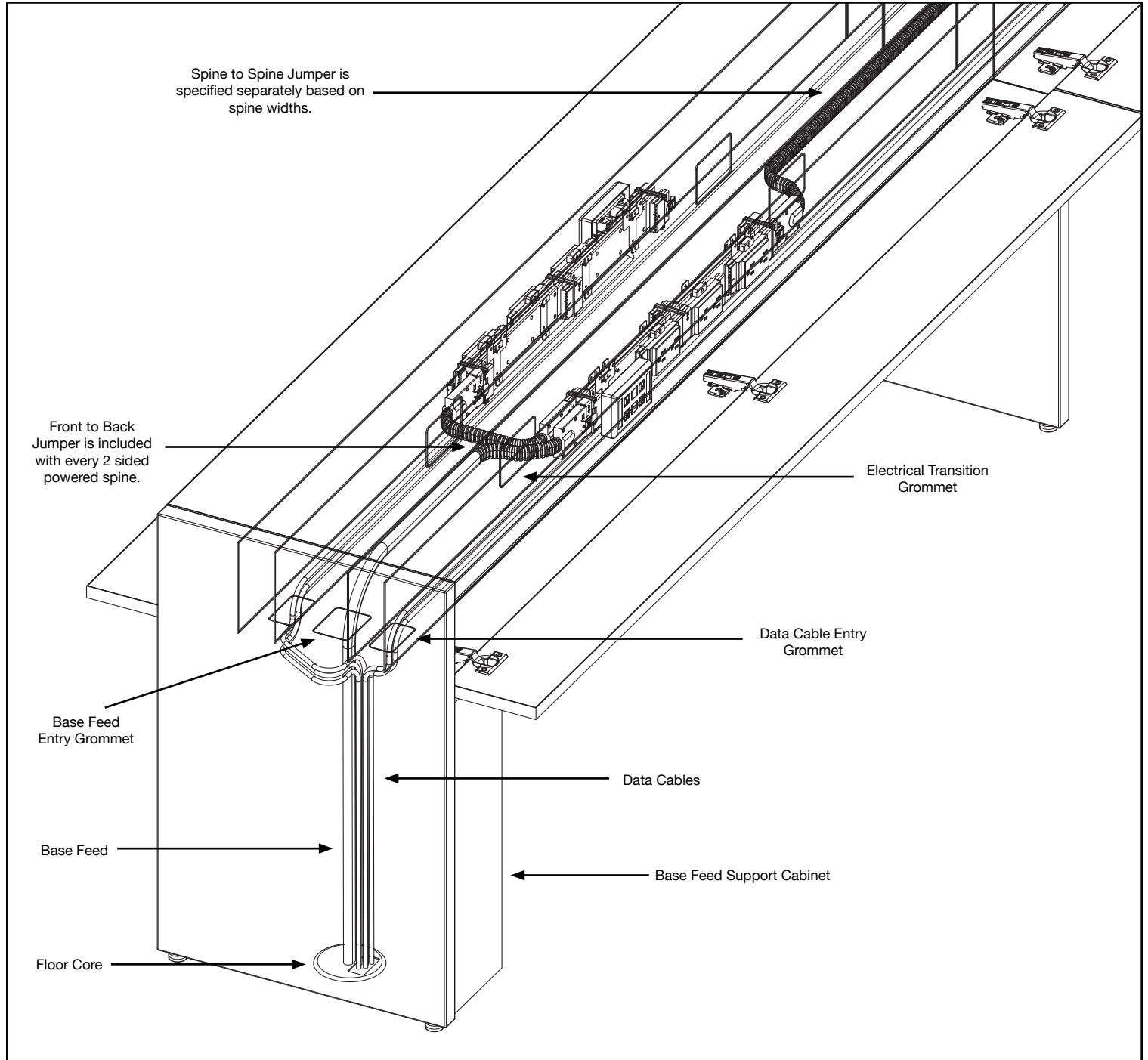

Calibrate Community Product Details

Community Spine Electrical: 8 Wire 4 Circuit

AIS Calibrate Community 8 Wire 4 Circuit electrical system contains four circuits. Each circuit is rated at 20 amps/120 volts maximum. Circuit 1, Circuit 2 and Circuit 3 are served by a system neutral and an equipment ground. Circuit 4 is dedicated and is served by its own neutral and ground. Circuit and ground conductors are #12 A.G.W. (gauge). All neutrals are #10 A.G.W. (gauge).

Shown below is a cross section of metal cable used for 8 Wire 4 Circuit jumpers and infeeds. Circuit and ground conductors are #12 A.G.W. (gauge). All neutrals are #10 A.G.W. (gauge).

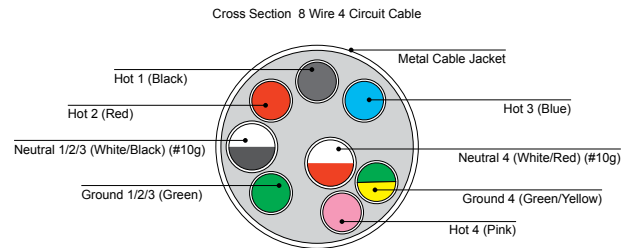
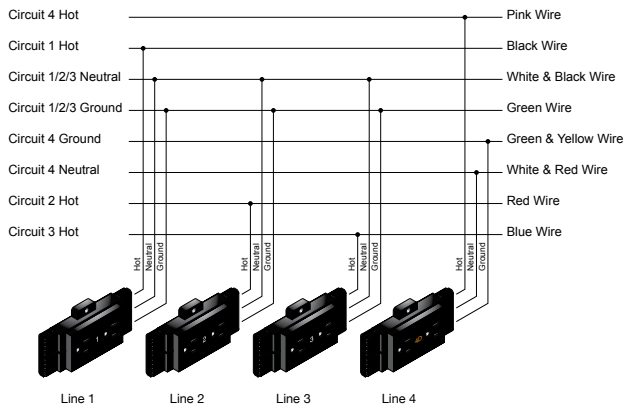

Community Spine Electrical: Duplex Outlets

Duplex Outlets are designated as circuits 1 through 4. Each duplex outlet contains two single receptacles (places to plug into) of the same circuit and are specified separately from powerways. All duplex outlets have black faces. The lettering on outlets for Circuit 1, 2 and 3 is white. The lettering on outlets for Circuit 4 is orange. Outlets are screw mounted to powerway. Duplex outlets are standard 15 amp outlets. For 20 amp outlets, call AIS Customer Service.

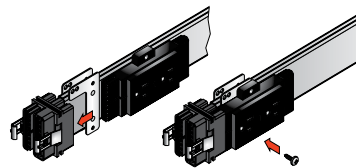

Common Equipment Amperages

Personal Computer	2.00 - 4.00
Laser Printer	5.00 - 8.00
Desktop Plotter	1.50
Fan	1.00
Heater	8.50 - 12.50
Tasklight	1.00
Slide Projector	2.00 - 6.00
Coffee Pot	15.00
Paper Shredder	4.40 - 13.00
Radio	0.05
Pencil Sharpener	1.00
Calculator	0.25
Answering Machine	0.08

Calibrate Community Product Details

Height Adjustable Table Considerations with 29" High Spine

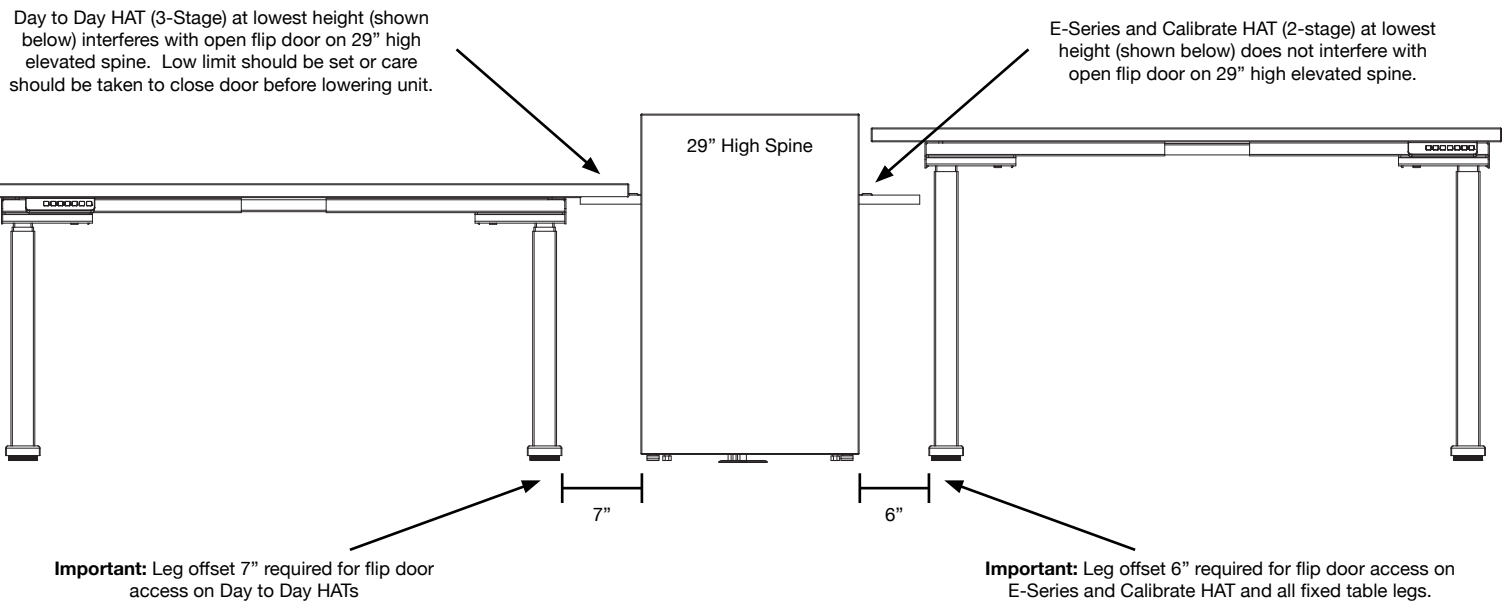

Height Adjustable Table Considerations with 21" High Spine

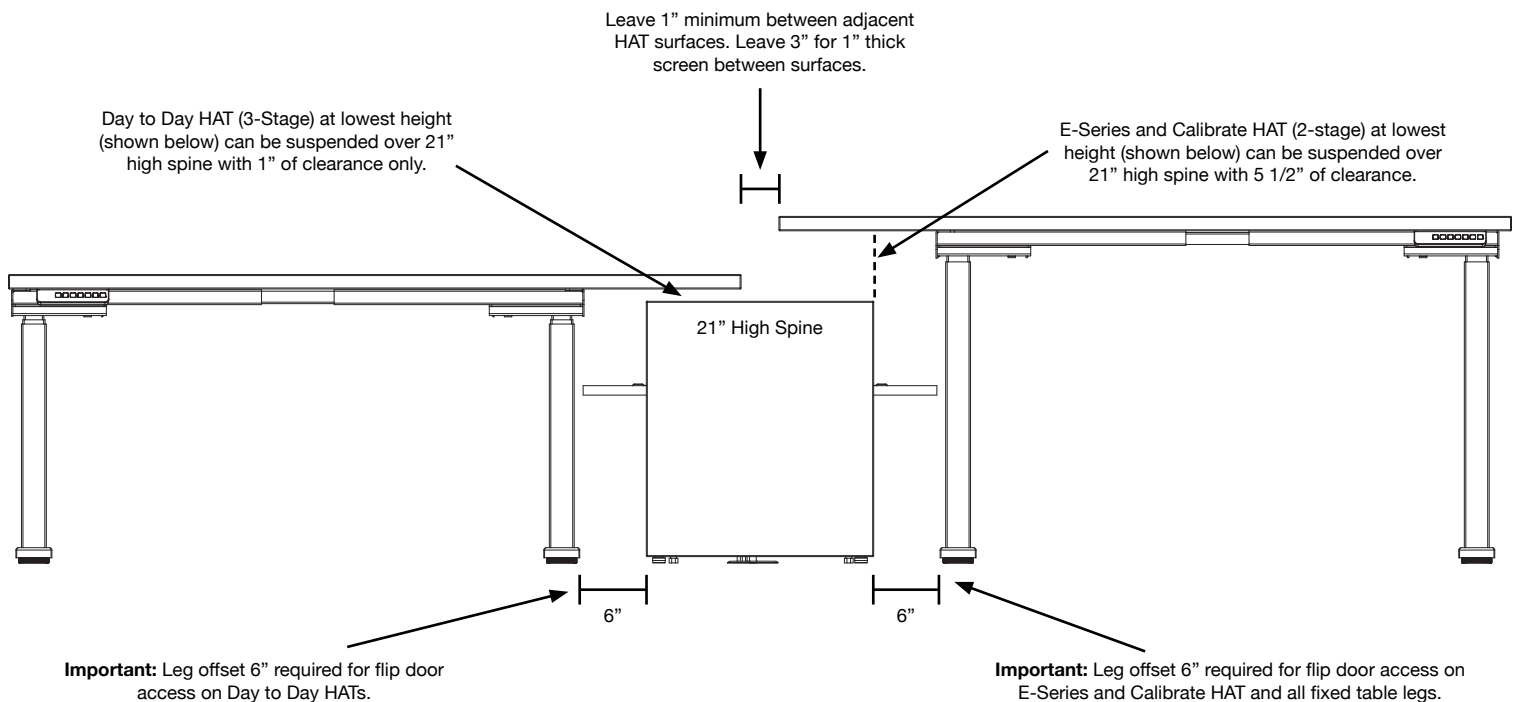

Community Spine Storage Considerations

End Panels must be used to cover spine ends in all cases, even when supported by storage elements.

End Panels must be used to cover spine ends in all cases, even when supported by storage elements.

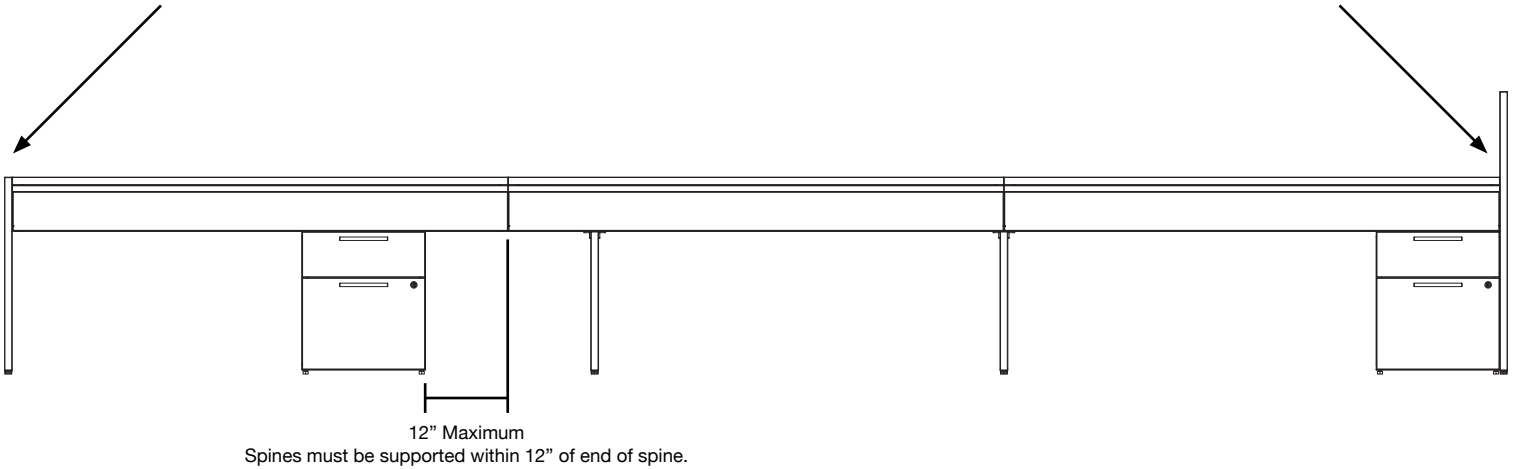

Stack storage must ALWAYS be supported from spines that are directly supported by floor storage or mid supports on at least one side.

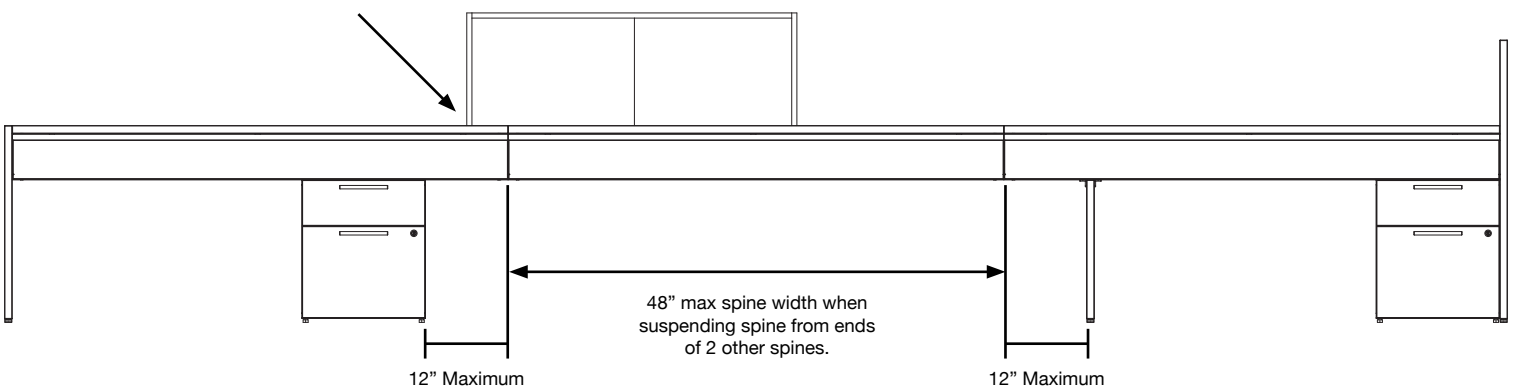

Calibrate Community Product Details

Wood Grain Direction

Grain direction runs vertical for all pieces except for the back of 48" wide cabinets, in which case it runs horizontal. Calibrate wood grain is always vertical on storage fronts and doors. Grains run vertically on items under 60" wide. Items over 60" wide have the grain will run horizontally.

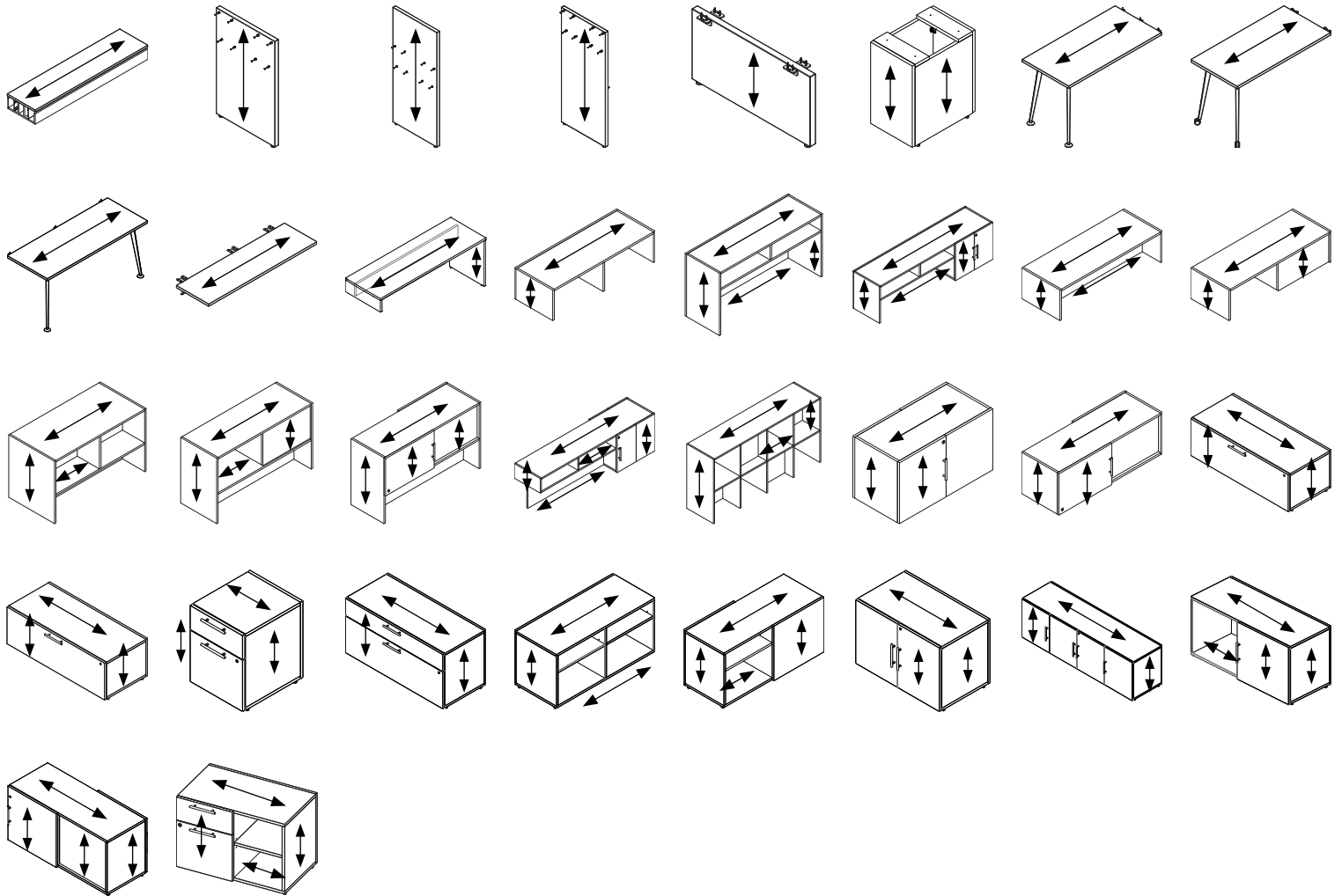

21" High Spine Application with Components

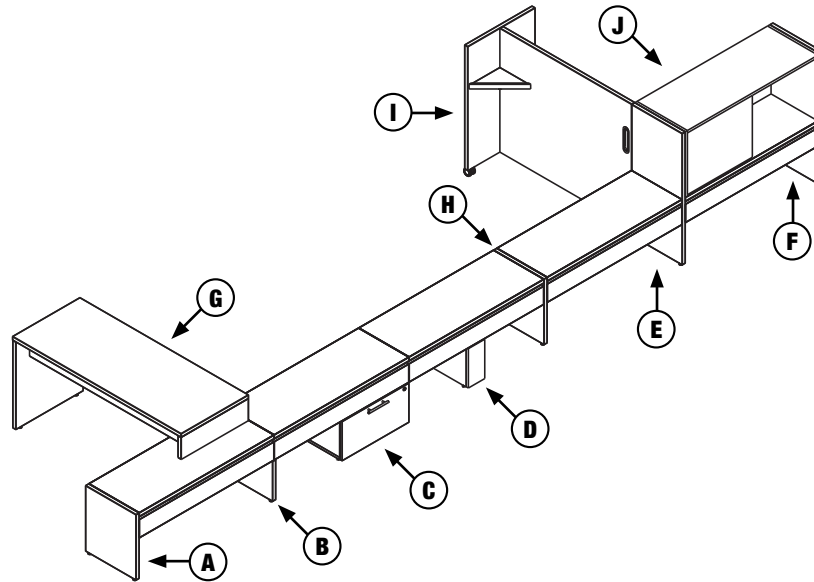

- A. **21" High Top Mount End Panel** - Used at end of spine to support spine flush with top of end panel and finish end of spine. Adds 1 1/8th" to spine length. Specify end panel that matches spine depth chosen.
- B. **13" High Mid Support** - Used to support spine at 21" high at seam between two adjacent spines. Specify end panel that matches spine depth chosen.
- C. **13" High Storage** - Provides lockable personal storage beneath 21" high spine and used to support spine.
- D. **13" High Infeed Base Support** - Has removable front and back panels and an open bottom to provide entrance for electrical and data cables.
- E. **42" High Shared Mid Mount End Panel with 21" High Mount Height** - Supports the ends of 2 spines at 21" high with a section of panel above spine mounting height to act as a finished end for storage or screens or to create a space for adjacent gallery panels and rolling whiteboards. Adds 1 1/8th" to spine length. Specify end panel that matches spine depth chosen.
- F. **42" High Mid Mount End Panel with 21" High Mount Height** - Supports and finishes end of spine with section of panel above spine mounting height to act as a finished end for storage or screens if desired. Adds 1 1/8th" to spine length. Specify end panel that matches spine depth chosen.
- G. **Stack-On Desks** - Available to stack on top of 21 high spines or 21" high storage elements.
- H. **21" High Shared Top Mount End Panel** - Used between 2 spine to support spine flush with top of end panel and to provide a 1 1/8th space between spine for placement of screens and dividers. Adds 1 1/8th" to spine length. End panel has cutout for passing electrical and data cables. Specify end panel that matches spine depth chosen.
- I. **42" High Tri-Wheel Whiteboard/Divider**
- J. **20" High Spine Hutch B Open Right**

Calibrate Community Product Details

29" High Spine Application with Components

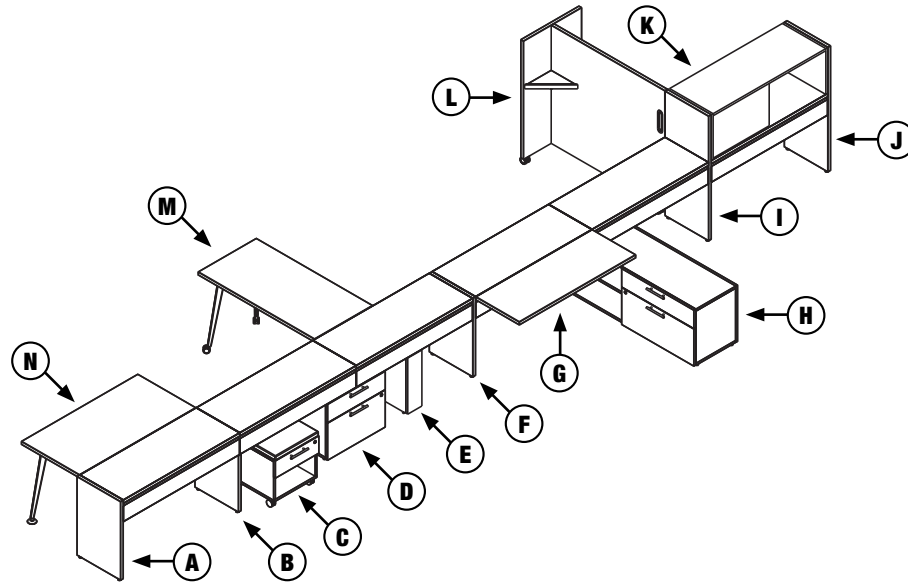

- A. **29" High Top Mount End Panel** - Used at end of spine to support spine flush with top of end panel and finish end of spine. Adds 1 1/8th" to spine length. Specify end panel that matches spine depth chosen.
- B. **21" High Mid Support** - Used to support spine at 29" high at seam between two adjacent spines. Specify end panel that matches spine depth chosen.
- C. **18" High Mobile Storage** - Designed to be stored under 29" high spines.
- D. **21" High Storage** - Can be used to support 29" high spines and are available in many configurations.
- E. **21" High Infeed Base Support** - Has removable front and back panels and an open bottom to provide entrance for electrical and data cables.
- F. **29" High Shared Top Mount End Panel** - Used between 2 spine to support spine flush with top of end panel and to provide a 1 1/8th space between spine for placement of screens and dividers. Adds 1 1/8th" to spine length. End panel has cutout for passing electrical and data cables. Specify end panel that matches spine depth chosen.
- G. **18" Deep Cantilevered Worksurface** - Can be mounted on spines that are supported with Storage below. Cantilevered surface does not impede flip door electrical access.
- H. **21" High Storage** - Can be used to support 29" high spine, shown here turned perpendicular to spine.
- I. **42" High Shared Mid Mount End Panel with 29" High Mount Height** - Supports the ends of 2 spines at 29" high with a section of panel above spine mounting height to act as a finished end for storage or screens or to create a space for adjacent gallery panels and rolling whiteboards. Adds 1 1/8th" to spine length. Specify end panel that matches spine depth chosen.
- J. **42" High Mid Mount End Panel with 29" High Mount Height** - Supports and finishes end of spine with section of panel above spine mounting height to act as a finished end for storage or screens if desired. Adds 1 1/8th" to spine length. Specify end panel that matches spine depth chosen.
- K. **20" High Spine Hutch B Open Right** - Used for storage and space division.
- L. **42" High Tri-Wheel Whiteboard/Divider**
- M. **Sliding Run-off Surfaces and Fixed Run-off Surfaces** - Can be specified for 29" high spines and mount with short side parallel to spine. Sliding Run-off Surfaces can be specified with glides or casters. Track for mounting ordered separately based on spine width. Sliding surfaces can slide along spine continuously as long as tracks are ordered for adjacent spines. Sliding surfaces CANNOT slide past Shared End Panels. Fixed Run-Off Surfaces are stationary and do not require track for mounting. Run-off surfaces do not impede flip door access to electrical.
- N. **Fixed Spine Surfaces** - Mount with long side parallel to spine and are supported at front with 2 legs. Fixed Spine Surfaces do not impede flip door access to electrical.

Typical 1

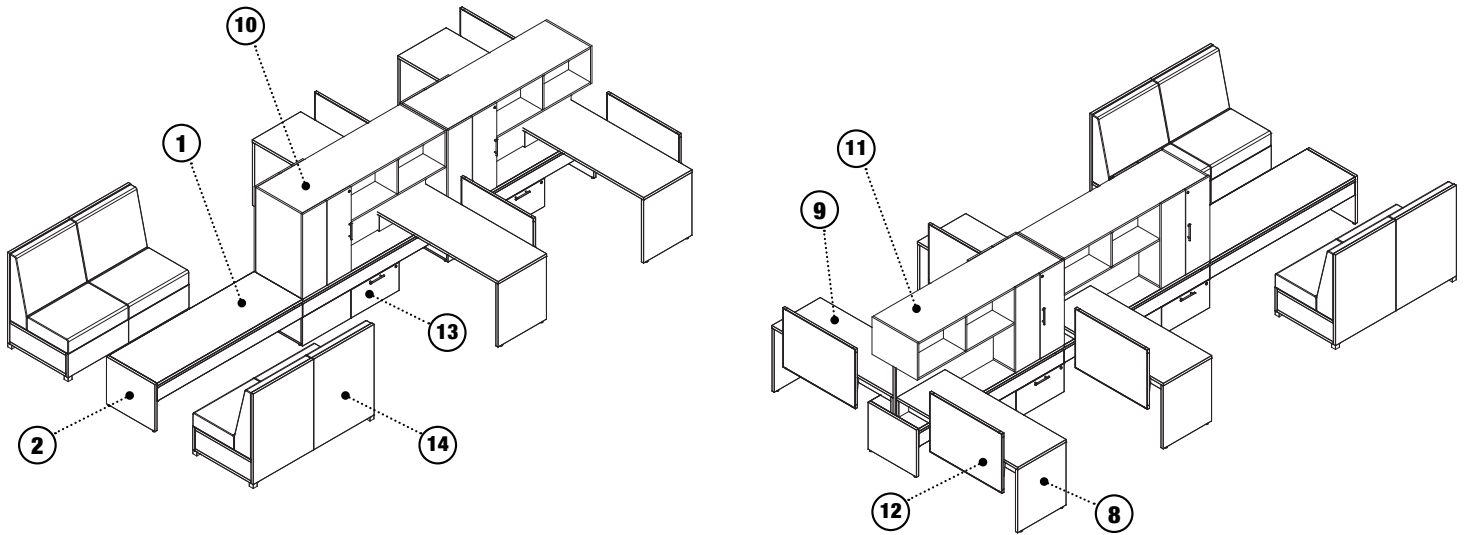

Description	Model Number	Quantity	Notes
1. Double Sided Powered Spine 72" Wide x 24" Deep	C-COMSP2-7224	3x	
2. Top Mount End Panels	C-CEP2421	2x	
3. Duplex Outlets - Line 1	E-MW8W4DO1	6x	
4. USB Outlets - Line 2	E-UN8W4USB02	6x	
5. Duplex Outlets - Line 4	E-MW8W4DO4	6x	
6. Electrical Jumpers 61" Long	E-MW8W4PJ42	2x	
7. Side-Mounted Base Infeed	E-UN8W4BIFS	1x	
8. Stack-On Desk Left Modesty 28" High x 60" Wide x 24" Deep	X-SODL286024	2x	
9. Stack-On Desk Right Modesty 28" High x 60" Wide x 24" Deep	X-SODR286024	2x	
10. Spine Hutch H Full Panel 36" High x 72" Wide x 24" Deep	C-CSH367224HF	2x	
11. Fabric Tackboard for Spine Hutch H (Full Panel) 36" High x 72" Wide	C-CTACKF3672HF	4x	
12. Fabric/Whiteboard/Laminate/Vinyl Partial Modesty Undersurface Mount Slimline Screen 26" High x 36" Wide	O-SMH2636	4x	See Oxygen Price List for details.
13. 13" High Storage with Bottom and Hidden Top Box Drawer 24" Wide x 24" Deep	C-CLATB2424	4x	
14. Configurable LB Lounge Solid Base 2-Seater	F-SSS426030C	2x	See Seating Price List for details.

Calibrate Community Typicals

Typical 2

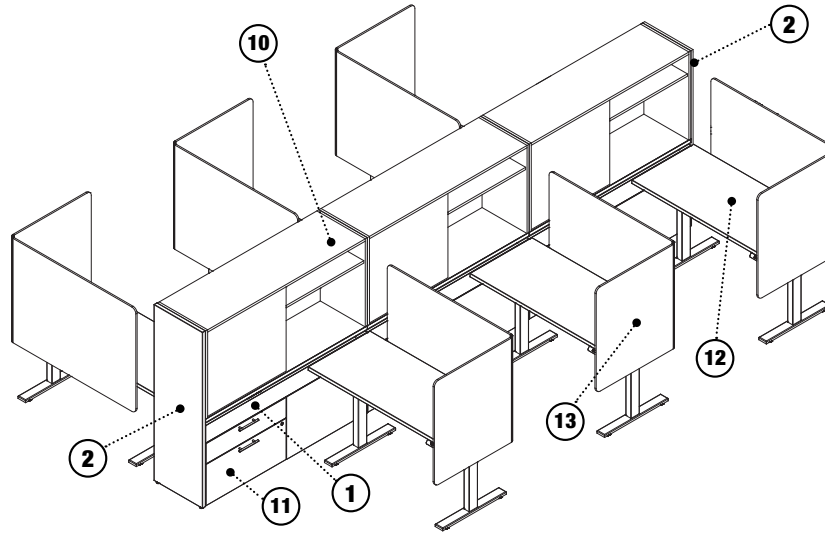

Description	Model Number	Quantity	Notes
1. Double Sided Powered Spine 60" Wide x 18" Deep	C-COMSP2-6018	3x	
2. Mid Mount End Panels 18" Deep x 58" High	C-CEP185829	2x	
3. Duplex Outlets - Line 1	E-MW8W4DO1	6x	
4. Duplex Outlets - Line 2	E-MW8W4DO2	6x	
5. Duplex Outlets - Line 4	E-MW8W4DO4	6x	
6. Electrical Jumpers 48" Long	E-UN8W4J48	2x	
7. Infeed Base Support 18" Deep x 6" Wide x 21" High	C-CIBS180621	1x	
8. Single Gang Plate Adapters	E-DJA	6x	
9. Side-Mounted Base Infeed	E-UN8W4BIFS	1x	
10. Spine Hutch B Open Right 28" High x 72" Wide x 18" Deep	C-CSH287218BR	3x	
11. BF Lateral 21" High x 30" Wide x 18" Deep	X-PLAT2D3018	1x	
11. BF Lateral 21" High x 36" Wide x 18" Deep	X-PLAT2D3618	5x	
12. E Series 2mm Edge Rectangular Table with Height Adjustable Bases 24" Deep x 54" Wide x 29" High	T-RCR245429HG	6x	See Tables Price List for details.
13. PET L-Wrap Partial Modesty Under Surface Mount Lite Screens Right Hand 34" High x 48" Wide x 24" Deep	Y-5M4J2R342448B	6x	See Tables Price List for details.

Typical 3

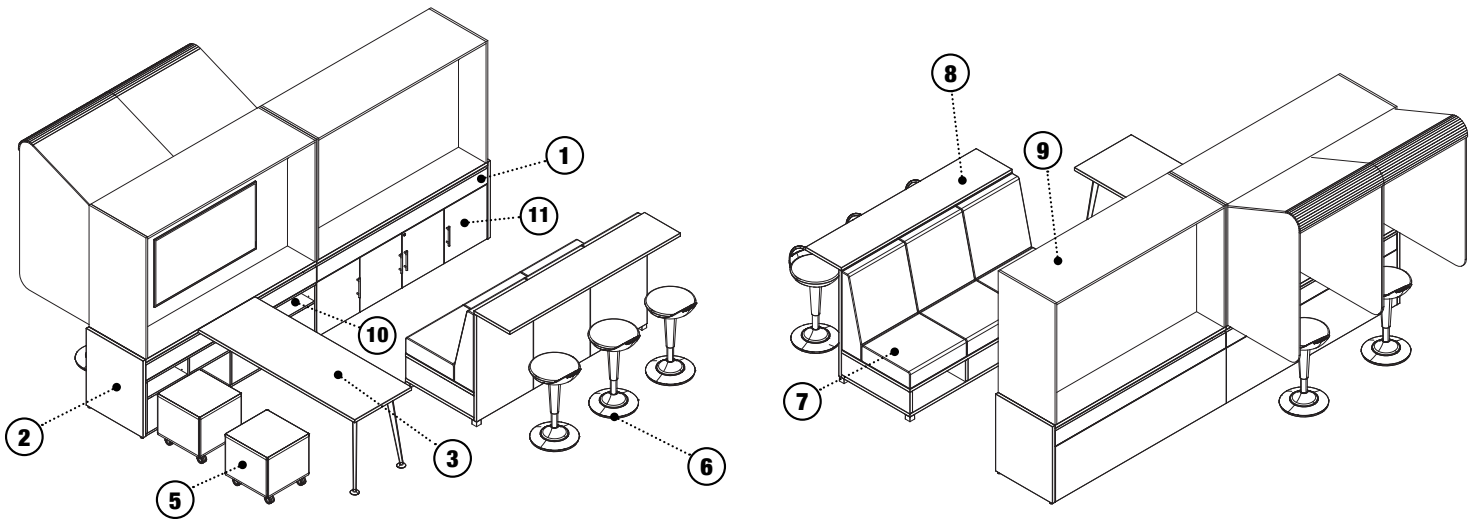

Description	Model Number	Quantity	Notes
1. Double Sided Powered Spine 72" Wide x 24" Deep	C-COMSP2-7224	2x	
2. Top Mount End Panels 24" Deep x 29" High	C-CEP2429	2x	
3. 2mm Edge Sliding Run-Off 29" High x 66" Wide x 24" Deep	C-CSRR2466G	1x	
4. Sliding Run-Off Track 72" Wide	C-CRRT72	1x	
5. Volker Cube 18" High x 18" Wide x 18" Deep	F-CUBE181818	2x	See Seating Price List for details.
6. Rutland Perch	6470C	3x	See Seating Price List for details.
7. Configurable LB Lounge Solid Base 3-Seater 42" High x 72" Wide x 30" Deep	F-SSS427230C	1x	See Seating Price List for details.
8. LB Ledge 13" Deep x 72" Wide	F-LBLL1372	1x	See Seating Price List for details.
9. Community Spine Hutch A 44" High x 72" Wide x 24" Deep	C-CSH447224A	2x	Coming soon.
10. Floor Bookcase 21" High x 72" Wide x 24" Deep	X-CBC207224	1x	
11. Four Door Cabinet 21" High x 72" Wide x 24" Deep	X-4DC722421	1x	Coming soon.
12. Duplex Outlets - Line 1	E-MW8W4DO1	4x	
13. Duplex Outlets - Line 2	E-UN8W4USB02	4x	
14. Duplex Outlets - Line 4	E-MW8W4DO4	4x	
15. Electrical Jumpers 61" Long	E-MW8W4PJ42	1x	
16. Side-Mounted Base Infeeds	E-UN8W4BIFS	1x	

Calibrate Community Typicals

Typical 4

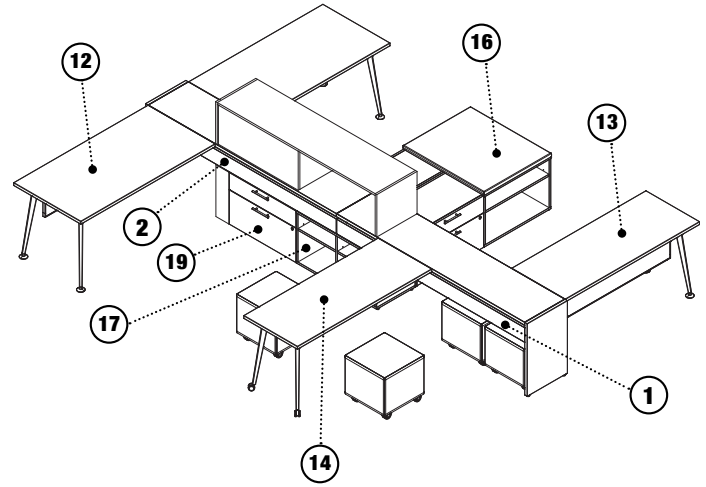
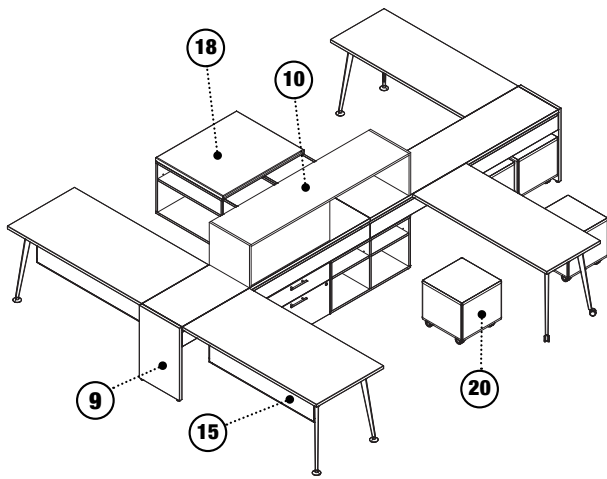

Description	Model Number	Quantity	Notes
1. Double Sided Powered Spine 84" Wide x 18" Deep	C-COMSP2-8418	2x	
2. Infeed Base Support 18" Deep x 6" Wide x 21" High	C-CIBS180621	1x	
3. Side-Mounted Base Infeed	E-UN8W4BIFS	1x	
4. Duplex Outlets - Line 1	E-MW8W4DO1	4x	
5. USB Outlets - Line 2	E-UN8W4USB02	4x	
6. Duplex Outlets - Line 4	E-MW8W4DO4	4x	
7. Single Gang Plate Adapters	E-DJA	4x	
8. Electrical Jumpers 69" Long	E-MW8W4PJ48E	1x	
9. Top Mount End Panels 18" Deep x 29" High	C-CEP1829	2x	
10. Spine Hutch B Open Right 12" High x 72" Wide x 18" Deep	C-CSH127218BR	1x	
11. Sliding Run-Off Tracks 84" Wide	C-CRRT84	4x	
12. 2mm Edge Sliding Run-Off w/ Glides 29" High x 60" Wide x 30" Deep	C-CSRR3060G	2x	
13. 2mm Edge Sliding Run-Off w/ Glides 29" High x 60" Wide x 24" Deep	C-CSRR2460G	1x	
14. 2mm Edge Sliding Run-Off w/ Casters 29" High x 60" Wide x 24" Deep	C-CSRR2460C	1x	
15. Front/Rear Surface Mount Slimline Screens 12" High x 48 Wide	Y-6R1A1U1248B	3x	See Screens Price List for details.
16. Floor Bookcases 21" High x 30" Wide x 18" Deep	X-CBC2030	2x	
17. Floor Bookcases 21" High x 36" Wide x 18" Deep	X-CBC2036	1x	
18. Shared Credenza Cushion 36" Deep x 30" Wide	S-BCUSH3630	1x	See Calibrate Price List for details.
19. BF Lateral 21" High x 30" Wide x 18" Deep	X-PLAT2D3018	3x	
20. Volker Cube 18" High x 18" Wide x 18" Deep	F-CUBE181818	4x	See Seating Price List for details.

Typical 5

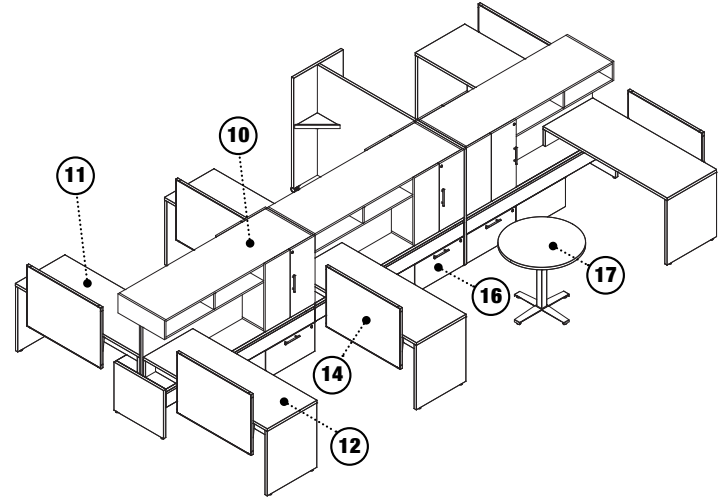
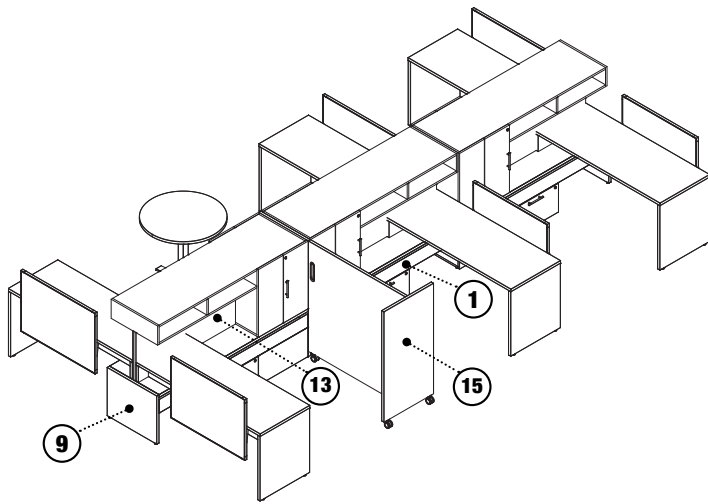

Description	Model Number	Quantity	Notes
1. Double Sided Powered Spine 72" Wide x 24" Deep	C-COMSP2-7224	3x	
2. Side-Mounted Base Infeed	E-UN8W4BIFS	1x	
3. Single Gang Plate Adapters	E-DJA	6x	
4. Duplex Outlets - Line 1	E-MW8W4DO1	6x	
5. USB Outlets - Line 2	E-UN8W4USB02	6x	
6. Duplex Outlets - Line 4	E-MW8W4DO4	6x	
8. Electrical Jumpers 61" Long	E-MW8W4PJ42	2x	
9. Top Mount End Panels 24" Deep x 21" High	C-CEP2421	2x	
10. Spine Hutch F Full Panel 28" High x 72" Wide x 24" Deep	C-CSH287224HF	3x	
11. Stack-On Desk Right Modesty 29" High x 60" Wide x 24" Deep	X-SODR286024	3x	
12. Stack-On Desk Left Modesty 29" High x 60" Wide x 24" Deep	X-SODL286024	3x	
13. Fabric Tackboard for Spine Hutch H Full Panel 28" High x 72" Wide	C-CTACKF2872HF	6x	
14. Fabric/Whiteboard/Laminate/Vinyl Partial Modesty Undersurface Mount Slimline Screen 26" High x 36" Wide	O-SMH2636	6x	See Oxygen Price List for details.
15. Tri-Wheel Mobile Laminate Whiteboard/Divider 24" Deep x 54" Wide x 50" High	A-TWWB502454	1x	See Accessories Price List for details.
16. 13" High Storage with Bottom and Hidden Top Box Drawer 24" Wide x 24" Deep	C-CLATB2424	6x	
17. 2mm Edge Round Table with Tapered Post Legs 36" Deep x 29" High	T-RDR3629TPG	1x	See Tables Price List for details.

Calibrate Community Typicals

Typical 6

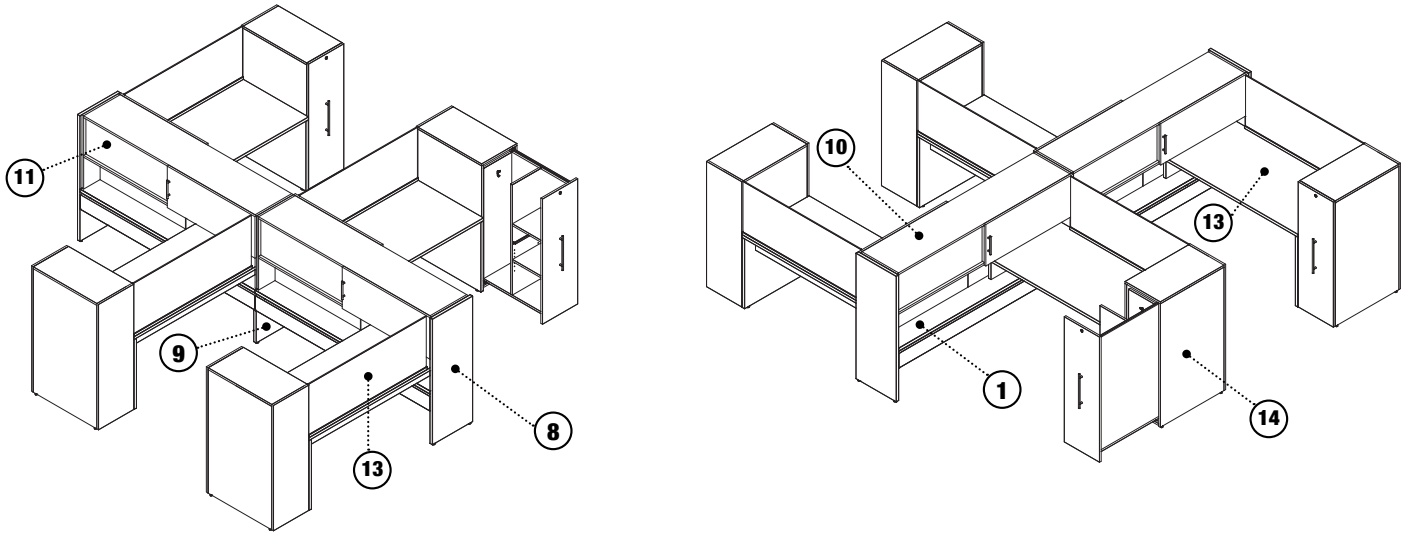

Description	Model Number	Quantity	Notes
1. Double Sided Powered Spine 78" Wide x 18" Deep	C-COMSP2-7818	2x	
2. Single Gang Plate Adapters	E-DJA	4x	
3. Duplex Outlets - Line 1	E-MW8W4DO1	4x	
4. USB Outlets - Line 2	E-UN8W4USB02	4x	
5. Duplex Outlets - Line 4	E-MW8W4DO4	4x	
6. Side-Mounted Base Infeed	E-UN8W4BIFS	1x	
7. Electrical Jumpers 67" Long	E-MW8W4PJ48	1x	
8. Mid Mount End Panels 18" Deep x 50" High	C-CEP185021	2x	
9. Mid Support 18" Deep x 13" High	C-CMSP1821	1x	
10. Spine Hutch E Door Right 28" High x 78" Wide x 18" Deep	C-CSH287818ER	2x	
11. PET Tackboard for Spine Hutch E 28" High x 42" Wide	C-CTACK2842E	4x	
12. Stack-On Desks Right Modesty 29" High x 60" Wide x 30" High	X-SODR286030	4x	
13. Glass 3/8" Front/Rear Surface Mount Channel Screen 20" High x 54" Wide	Y-4R2H1U2054B	4x	See Aloft Price List for details.
14. Side Access Roll Out/Pantry Tower Right Handed 50" High x 15.75" Wide x 30" Deep	X-SARTR501530	4x	See Calibrate Price List for details.

Typical 7

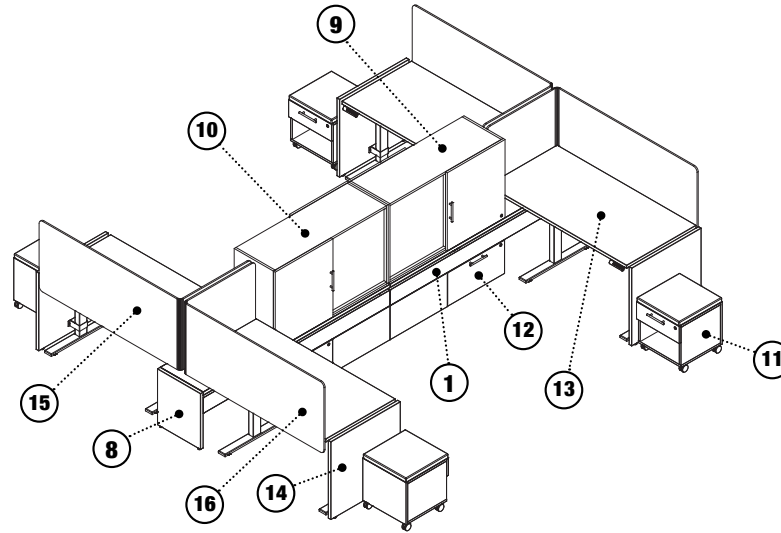

Description	Model Number	Quantity	Notes
1. Double Sided Powered Spine 78" Wide x 18" Deep	C-COMSP2-7818	2x	
2. Single Gang Plate Adapters	E-DJA	4x	
3. Duplex Outlets - Line 1	E-MW8W4DO1	4x	
4. USB Outlets - Line 2	E-UN8W4USB02	4x	
5. Duplex Outlets - Line 4	E-MW8W4DO4	4x	
6. Electrical Jumpers 67" Long	E-MW8W4PJ48	1x	
7. Side-Mounted Base Infeed	E-UN8W4BIFS	1x	
8. Top Mount End Panels 18" Deep x 21" High	C-CEP1821	2x	
9. Spine Cabinet M Door Right 28" High x 48" Wide x 18" Deep	C-CSC284818MR	1x	
10. Spine Cabinet M Door Left 28" High x 48" Wide x 18" Deep	C-CSC284818ML	1x	
11. Bottom Cubby Box Mobile Pedestal	C-PCFLCN181818	4x	
12. 13" High Storage with Single Bottom Box Drawer 24" Wide x 18" Deep	C-CLATF1824	4x	
13. E Series 2mm Edge Rectangular Table with Height Adjustable Bases 30" Deep x 60" Wide x 29" High	T-RCR306029HG	4x	See Tables Price List for details.
14. End Panels for Day-to-Day Tables with Height Adjustable Bases 30" Deep x 29" High	T-EPHAT2930	4x	See Tables Price List for details.
15. PET L-Wrap Partial Modesty Under Surface Mount Lite Screens Left Hand 26" High x 60" Wide x 30" Deep	Y-5M4J2L263060B	2x	See Tables Price List for details.
16. PET L-Wrap Partial Modesty Under Surface Mount Lite Screens Right Hand 26" High x 60" Wide x 30" Deep	Y-5M4J2R263060B	2x	See Tables Price List for details.

Calibrate Community Typicals

Typical 8

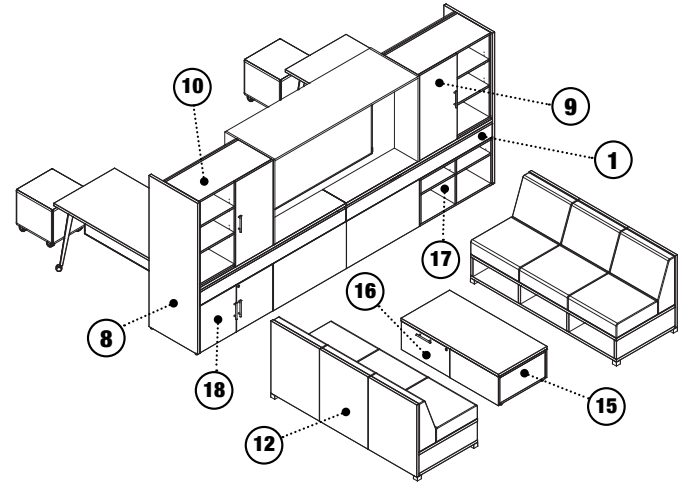
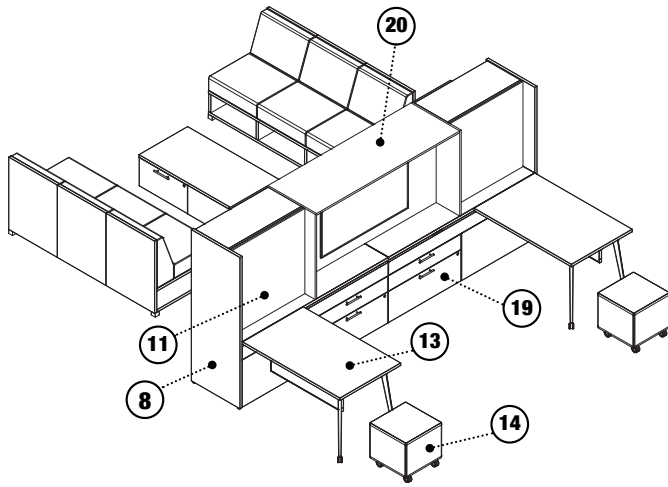

Description	Model Number	Quantity	Notes
1. Single Sided Powered Spine 72" Wide x 24" Deep	C-COMSP1-7224	2x	
2. Single Gang Plate Adapters	E-DJA	2x	
3. Duplex Outlets - Line 1	E-MW8W4DO1	2x	
4. USB Outlets - Line 2	E-UN8W4USB02	2x	
5. USB Outlets - Line 4	E-UN8W4USB04	2x	
6. Electrical Jumpers 61" Long	E-MW8W4PJ42	1x	
7. Side-Mounted Base Infeeds	E-UN8W4BIFS	1x	
8. Mid Mount End Panels 24" Deep x 66" High	C-CEP246629	2x	
9. Stack-On Bookcase with Sliding Doors Left Handed 37" High x 36" Wide x 14" Deep	X-SOSDL3736	1x	See Calibrate Price List for details.
10. Stack-On Bookcase with Sliding Doors Right Handed 37" High x 36" Wide x 14" Deep	X-SOSDR3736	1x	See Calibrate Price List for details.
11. Vertical Wall Mounted Tackboard 37" High x 36" Wide	X-TACKSW3736	2x	See Calibrate Price List for details.
12. Configurable LB Lounge Open Base 3-Seater 34" High x 72" Wide x 30" Deep	F-SSC347230C	2x	See Seating Price List for details.
13. 2mm Edge Sliding Run-Off w/ Casters 29" High x 48" Wide x 30" Deep	C-CSRR3048C	2x	
14. Volker Cube 18" High x 18" Wide x 18" Deep	F-CUBE181818	2x	See Seating Price List for details.
15. Rectangular Worksurface 24" Deep x 48" Wide	W-WS2448	1x	See Worksurfaces Price List for details.
16. 13" High Storage with Single Bottom Box Drawer 24" Wide x 24" Deep	C-CLATF2424	2x	
17. Floor Bookcase 21" High x 36" Wide x 24" Deep	X-CBC203624	1x	See Calibrate Price List for details.
18. Two Door Cabinet 21" High x 36" Wide x 24" Deep	X-DDC362421	1x	Coming soon.
19. BF Laterals 21" High x 36" Wide x 24" Deep	X-PLAT2D3624	2x	
20. Spine Hutch A 36" High x 72" Wide x 24" Deep	C-CSH367224A	1x	
21. Sliding Run-Off Tracks 72" Wide	C-CRR72	2x	

Typical 9

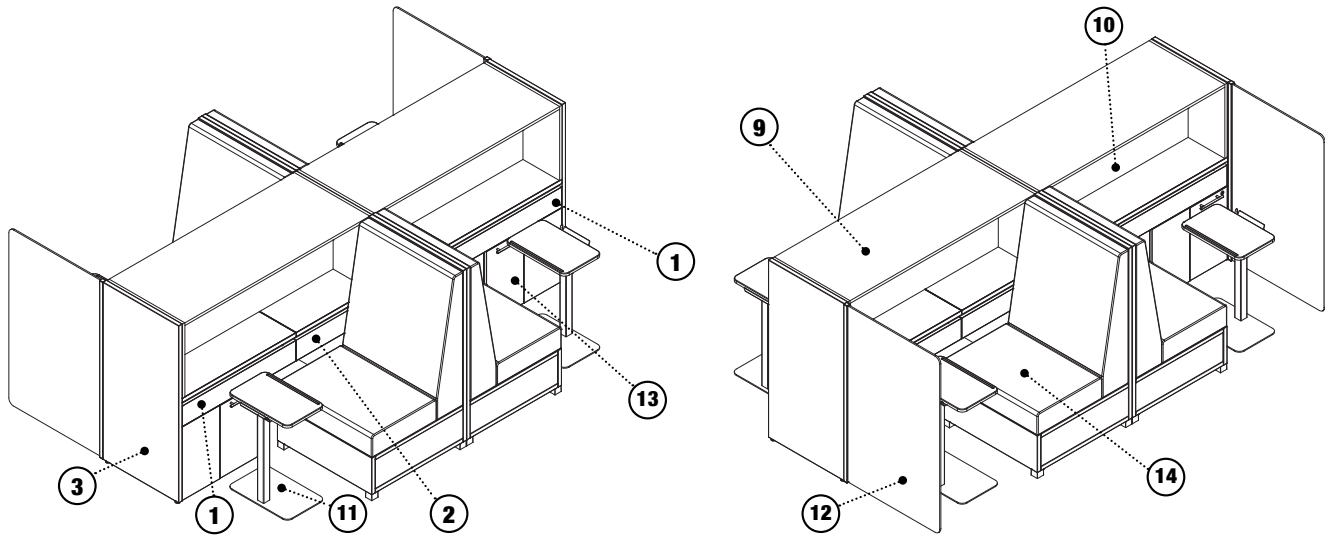

Description	Model Number	Quantity	Notes
1. Double Sided Powered Spine 36" Wide x 24" Deep	C-COMSP2-3624	2x	
2. Double Sided Powered Spine 48" Wide x 24" Deep	C-COMSP2-4824	1x	
3. Mid Mount End Panels 24" Deep x 50" High	C-CEP245029	2x	
4. Side-Mounted Base Infeeds	E-UN8W4BIFS	1x	
5. Electrical Jumpers 33" Long	E-HM8W4PJ24	2x	
6. USB Outlets - Line 1	E-UN8W4USB01	4x	
7. Duplex Outlets - Line 4	E-MW8W4DO4	4x	
8. Infeed Base Support 24" Deep x 12" Wide x 21" High	C-CIBS241221	1x	Centered under spine in center.
9. Spine Hutch A 20" High x 60" Wide x 24" Deep	C-CSH206024A	2x	
10. PET Tackboard for Spine Hutch A 20" High x 60" Wide	C-CTACK2060A	4x	
11. Laptop Table	T-LT	4x	See Tables Price List for details.
12. PET Gallery Panel Side Mount Channel Screens 50" High x 30" Wide	Y-5G2R1U5030B	2x	Coming soon.
13. Hidden Drawer BF Pedestal 21" High x 12" Wide x 24" Deep	X-BFPH211224	4x	
14. Configurable LB Lounge Solid Base 1-Seater 50" High x 30" Wide x 30" Deep	F-SSS503030C	4x	See Seating Price List for details.

Calibrate Community Typicals

Typical 10

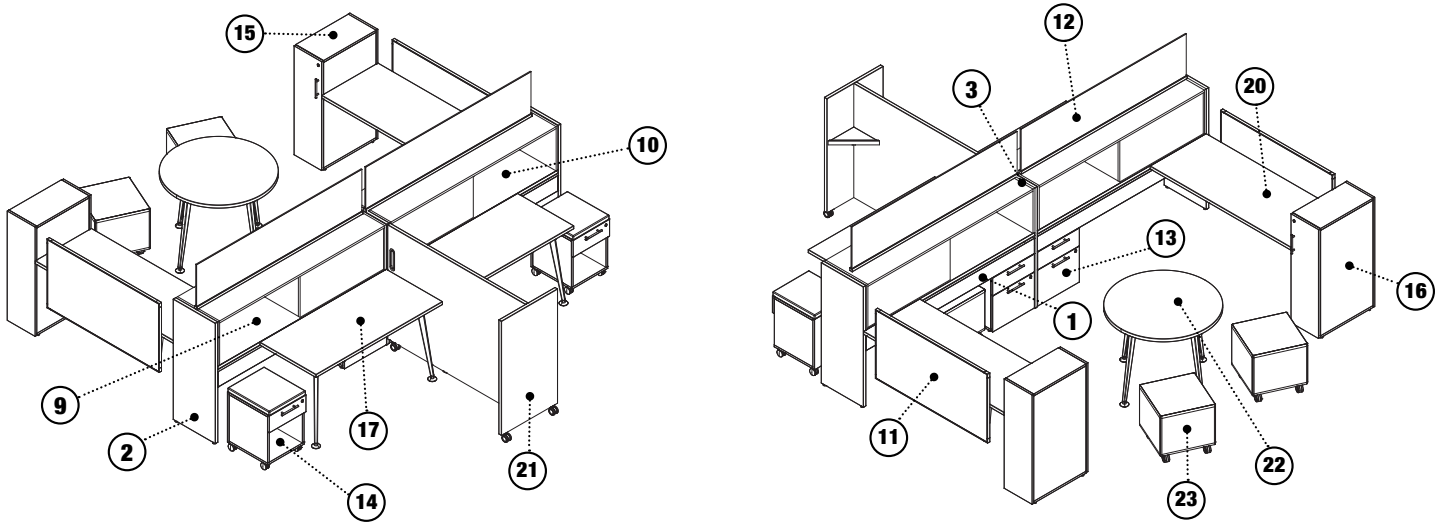

Description	Model Number	Quantity	Notes
1. Double Sided Powered Spine 72" Wide x 18" Deep	C-COMSP2-7218	2x	
2. Mid Mount End Panels 18" Deep x 46" Wide	C-CEP184629	2x	
3. Shared Mid Mount End Panels 18" Deep x 46" Wide	C-CEPMS184629	1x	
4. Duplex Outlets - Line 1	E-MW8W4DO1	4x	
5. Duplex Outlets - Line 2	E-MW8W4DO2	4x	
6. Single Gang Plate Adapters	E-DJA	4x	
7. Electrical Jumpers 61" Long	E-MW8W4PJ42	1x	
8. Side-Mounted Base Infeeds	E-UN8W4BIFS	1x	
9. Spine Hutch B Open Left 16" High x 72" Wide x 18" Deep	C-CSH167218BL	1x	
10. Spine Hutch B Open Right 16" High x 72" Wide x 18" Deep	C-CSH167218BR	1x	
11. Fabric/Whiteboard/Laminate/Vinyl Partial Modesty Undersurface Mount Slimline Screen 26" High x 48" Wide	O-SMH2648	2x	See Oxygen Price List for details.
12. Glass 3/8" Panel Top Surface Mount Channel Scree 16" High x 72" Wide	Y-4P2A1U1672B	2x	See Screens Price List for details.
13. BF Pedestals 21" High x 18" Wide x 18" Deep	X-BFPFS182118	2x	
14. Bottom Cubbie Box Mobile Pedestal with Cushion 21" High x 16" Wide x 18" Deep	C-PCFLCC162118	2x	Coming soon.
15. Single Door Cabinets Left Hinge 46" High x 12" Wide x 24" Deep	X-SDCL4624	1x	Coming soon.
16. Single Door Cabinets Right Hinge 46" High x 12" Wide x 24" Deep	X-SDCR4624	1x	Coming soon.
17. 2mm Edge Fixed Spine Surface with Tapered Legs 29" High x 54" Wide x 24" Deep	X-DROR2454TS	2x	
18. U-Channel 48" Wide	WPS-VC48	2x	See Support & Storage Price List for details.
19. Worksurface Support Bracket	O-WSLB	2x	See Calibrate Price List for details.
20. Rectangular Worksurface 24" Deep x 48" Wide	W-WS2460	2x	See Worksurface Price List for details.
21. Tri-Wheel Mobile Laminate Whiteboard/Divider 24" Deep x 60" Wide x 46" High	A-TWWB462460	1x	See Accessories Price List for details.
22. 2mm Edge Round Table with Tapered Post Legs 36" Deep x 29" High	T-RDR3629TPG	1x	See Tables Price List for details.
23. Volker Cube 18" High x 18" Wide x 18" Deep	F-CUBE181818	2x	See Seating Price List for details.

Typical 11

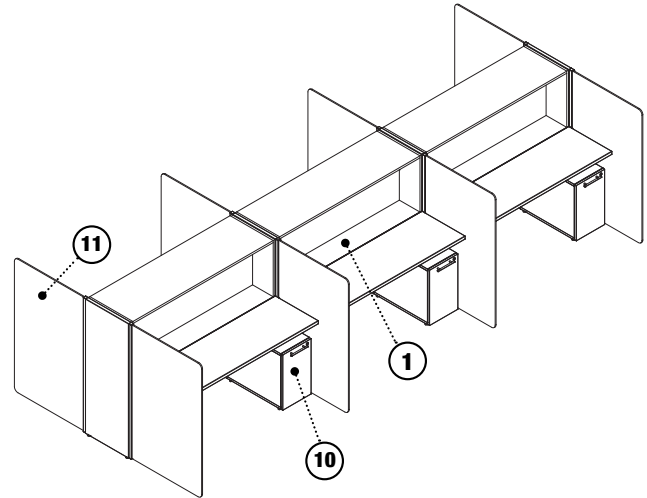
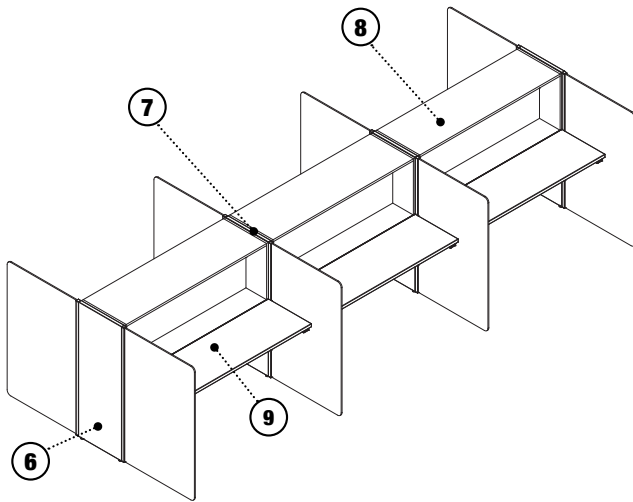

Description	Model Number	Quantity	Notes
1. Double Sided Powered Spine 60" Wide x 18" Deep	C-COMSP2-6018	3x	
2. USB Outlets - Line 1	E-UN8W4USB01	6x	
3. Duplex Outlets - Line 4	E-MW8W4DO4	6x	
4. Electrical Jumpers 48" Long	E-UN8W4J48	2x	
5. Side-Mounted Base Infeeds	E-UN8W4BIFS	1x	
6. Mid Mount End Panels 18" Deep x 50" High	C-CEP185029	2x	
7. Shared Mid Mount End Panels 18" Deep x 50" Wide	C-CEPMS185029	2x	
8. Spine Hutch A 20" High x 60" Wide x 18" Deep	C-CSH206018A	3x	
9. 2mm Edge Cantilevered Spine Surface 29" High x 60" Wide x 18" Deep	C-CCSSR1860	6x	
10. Hidden Drawer BF Pedestals 21" High x 12" Wide x 24" Deep	X-BFPH211224	6x	
11. PET Gallery Panel Side Mount Channel Screens 50" High x 30" Wide	Y-5G2R1U5030B	6	Coming soon.

Calibrate Community Typicals

Typical 12

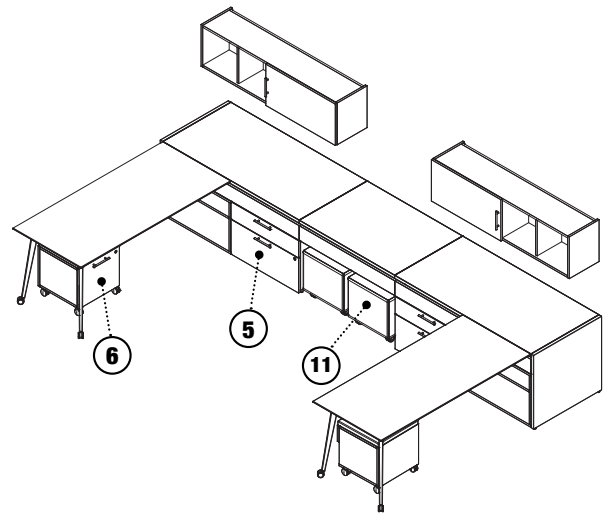
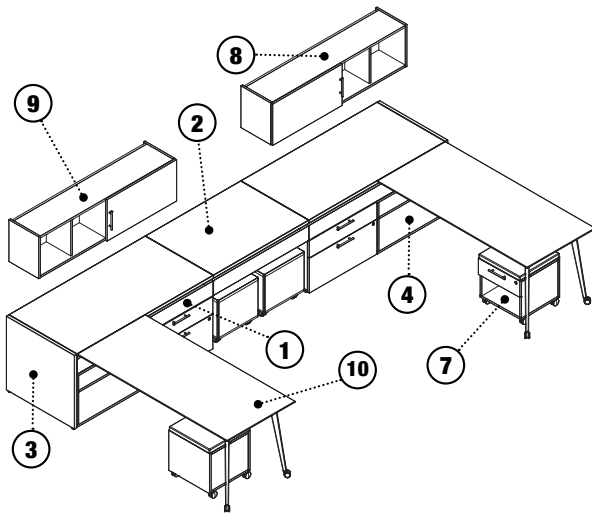

Description	Model Number	Quantity	Notes
1. Single Sided Powered Spine 60" Wide x 30" Deep	C-COMSP1-6030	2x	
2. Single Sided Powered Spine 42" Wide x 30" Deep	C-COMSP1-4230	1x	
3. Top Mount End Panels 30" Deep x 29" High	C-CEP3029	2x	
4. Floor Bookcases 21" High x 30" Wide x 24" Deep	X-CBC203024	2x	
5. BF Laterals 21" High x 30" Wide x 24" Deep	X-PLAT2D3024	2x	
6. Hidden Drawer BF Pedestal on Casters with Cushion 21" High x 16" Wide x 18" Deep	C-BFPDM16	1x	See Calibrate Price List for details.
7. Bottom Cubbie Box Mobile Pedestal with Cushion 21" High x 16" Wide x 18" Deep	C-PCFLCC162118	1x	See Calibrate Price List for details.
8. Wall Mounted Overhead Storage with Sliding Doors Left-Side Lock 16" High x 60" Wide x 14" Deep	C-OWMS166014LL	1x	See Calibrate Price List for details.
9. Wall Mounted Overhead Storage with Sliding Doors Right-Side Lock 16" High x 60" Wide x 14" Deep	C-OWMS166014RL	1x	
10. Knife Edge Sliding Run-Offs with Tapered Legs 29" High x 66" Wide x 30" Deep	C-CSRK3066C	2x	
11. Volker Cube 18" High x 18" Wide x 18" Deep	F-CUBE181818	2x	See Seating Price List for details.
12. Duplex Outlets - Line 1	E-MW8W4DO1	3x	
13. Duplex Outlets - Line 2	E-MW8W4DO2	3x	
14. Duplex Outlets - Line 4	E-MW8W4DO4	3x	
15. Electrical Jumpers 39" Long	E-HM8W4PJ30	2x	
16. Single Gang Plate Adapters	E-DJA	2x	
17. Side-Mounted Base Infeeds	E-UN8W4BIFS	1x	
18. Sliding Run-Off Tracks 60" Wide	C-CRRT60	2x	
19. Sliding Run-Off Tracks 42" Wide	C-CRRT42	1x	

Typical 13

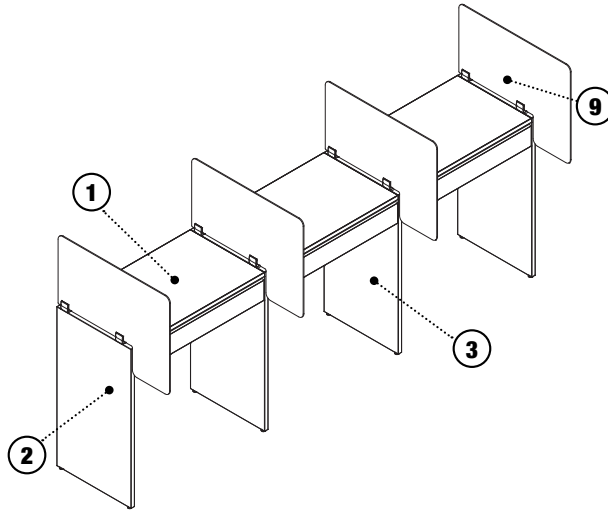

Description	Model Number	Quantity	Notes
1. Single Sided Powered Spine 42" Wide x 24" Deep	C-COMSP1-4224	3x	
2. Top Mount End Panels 24" Deep x 46" High	C-CEP2446	2x	
3. Shared Top Mount End Panels 24" Deep x 46" High	C-CEPTS2446	2x	
4. Duplex Outlets - Line 1	E-MW8W4DO1	3x	
5. USB Outlets - Line 2	E-UN8W4USB02	3x	
6. Duplex Outlets - Line 4	E-MW8W4DO4	3x	
7. Side-Mounted Base Infeeds	E-UN8W4BIFS	1x	
8. Electrical Jumpers 30" Long	E-UN8W4J30	2x	
9. Lexan 1/4" Territory Drop Surface Mount Clip Screen 20" High x 24" Wide	Y-1D3A1U2024B	4x	Coming soon.

Non-Powered Spines

NON-POWERED SPINE			
W	D	Model Number	List
24	18	C-COMSNP-2418	1,373
24	24	C-COMSNP-2424	1,427
24	30	C-COMSNP-2430	1,574
24	36	C-COMSNP-2436	1,628
30	18	C-COMSNP-3018	1,462
30	24	C-COMSNP-3024	1,529
30	30	C-COMSNP-3030	1,689
30	36	C-COMSNP-3036	1,756
36	18	C-COMSNP-3618	1,535
36	24	C-COMSNP-3624	1,618
36	30	C-COMSNP-3630	1,791
36	36	C-COMSNP-3636	1,873

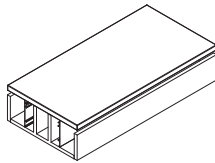

Specify	Notes
<ul style="list-style-type: none"> • Paint Selection for Internal Cover (Grade C Paint +10) • Laminate Choice 	<ul style="list-style-type: none"> • 8" high laminate cabinet with flip down doors on front and back. • Provides electrical and data distribution. • 1" gap above door maintained for egress of user power cords. • Internal centerline cavity for multi-circuit electrical cables. • External cavities on front and rear with metal cover provides lay-in data cable capabilities. • Non-powered does not include multi-circuit powerway. • Includes 2 non-powered (blank) internal covers.

Single Sided Powered Spines

SINGLE SIDED POWERED SPINE				SINGLE SIDED POWERED SPINE			
W	D	Model Number	List	W	D	Model Number	List
36	18	C-COMSP1-3618	1,999	66	18	C-COMSP1-6618	2,635
36	24	C-COMSP1-3624	2,236	66	24	C-COMSP1-6624	2,845
36	30	C-COMSP1-3630	2,286	66	30	C-COMSP1-6630	2,957
36	36	C-COMSP1-3636	2,372	66	36	C-COMSP1-6636	3,109
42	18	C-COMSP1-4218	2,079	72	18	C-COMSP1-7218	2,801
42	24	C-COMSP1-4224	2,329	72	24	C-COMSP1-7224	3,023
42	30	C-COMSP1-4230	2,422	72	30	C-COMSP1-7230	3,149
42	36	C-COMSP1-4236	2,491	72	36	C-COMSP1-7236	3,312
48	18	C-COMSP1-4818	2,286	78	18	C-COMSP1-7818	2,880
48	24	C-COMSP1-4824	2,457	78	24	C-COMSP1-7824	3,115
48	30	C-COMSP1-4830	2,623	84	18	C-COMSP1-8418	2,997
48	36	C-COMSP1-4836	2,736	84	24	C-COMSP1-8424	3,244
54	18	C-COMSP1-5418	2,460	90	18	C-COMSP1-9018	3,077
54	24	C-COMSP1-5424	2,643	90	24	C-COMSP1-9024	3,337
54	30	C-COMSP1-5430	2,731	96	18	C-COMSP1-9618	3,154
54	36	C-COMSP1-5436	2,855	96	24	C-COMSP1-9624	3,427
60	18	C-COMSP1-6018	2,555				
60	24	C-COMSP1-6024	2,752				
60	30	C-COMSP1-6030	2,852				
60	36	C-COMSP1-6036	2,990				

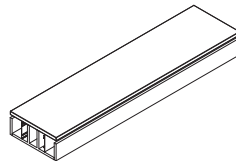

Specify	Notes
<ul style="list-style-type: none"> • Paint Selection (Grade C Paint +10) • Laminate Choice 	<ul style="list-style-type: none"> • 8" high laminate cabinet with flip down doors on front and back. • Provides electrical and data distribution. • 1" gap above door maintained for egress of user power cords. • Internal centerline cavity for multi-circuit electrical cables. • External cavities on front and rear with metal cover provides lay-in data cable capabilities. • Includes 8 wire 4 circuit powerway, centered left to right, facing one side only. • Accommodates up to 4 duplex outlets per powerway. • Specify up to 3 duplex outlets per powerway and one E-DJA Data Jack Adapter to accommodate data cable termination. • Includes 1 metal cover with 4 duplex Outlet holes and one non-powered (blank) cover.

Double Sided Powered Spines

DOUBLE SIDED POWERED SPINE				DOUBLE SIDED POWERED SPINE			
W	D	Model Number	List	W	D	Model Number	List
36	18	C-COMSP2-3618	2,377	66	18	C-COMSP2-6618	3,012
36	24	C-COMSP2-3624	2,614	66	24	C-COMSP2-6624	3,222
36	30	C-COMSP2-3630	2,664	66	30	C-COMSP2-6630	3,335
36	36	C-COMSP2-3636	2,749	66	36	C-COMSP2-6636	3,486
42	18	C-COMSP2-4218	2,456	72	18	C-COMSP2-7218	3,177
42	24	C-COMSP2-4224	2,707	72	24	C-COMSP2-7224	3,399
42	30	C-COMSP2-4230	2,768	72	30	C-COMSP2-7230	3,527
42	36	C-COMSP2-4236	2,867	72	36	C-COMSP2-7236	3,690
48	18	C-COMSP2-4818	2,663	78	18	C-COMSP2-7818	3,258
48	24	C-COMSP2-4824	2,834	78	24	C-COMSP2-7824	3,494
48	30	C-COMSP2-4830	3,001	84	18	C-COMSP2-8418	3,373
48	36	C-COMSP2-4836	3,114	84	24	C-COMSP2-8424	3,621
54	18	C-COMSP2-5418	2,862	90	18	C-COMSP2-9018	3,452
54	24	C-COMSP2-5424	3,021	90	24	C-COMSP2-9024	3,715
54	30	C-COMSP2-5430	3,109	96	18	C-COMSP2-9618	3,532
54	36	C-COMSP2-5436	3,233	96	24	C-COMSP2-9624	3,804
60	18	C-COMSP2-6018	2,933				
60	24	C-COMSP2-6024	3,127				
60	30	C-COMSP2-6030	3,230				
60	36	C-COMSP2-6036	3,367				

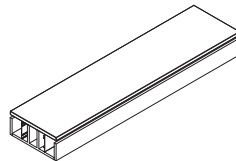

Specify	Notes
<ul style="list-style-type: none"> • Paint Selection (Grade C Paint +10) • Laminate Choice 	<ul style="list-style-type: none"> • 8" high laminate cabinet with flip down doors on front and back. • Provides electrical and data distribution. • 1" gap above door maintained for egress of user power cords. • Internal centerline cavity for multi-circuit electrical cables. • External cavities on front and rear with metal cover provides lay-in data cable capabilities. • Includes 8 wire 4 circuit powerway, centered left to right, facing both front and back. • Accommodates up to 4 duplex outlets per powerway (4 facing front, 4 facing back). • Specify up to 3 duplex outlets per powerway and one E-DJA Data Jack Adapter to accommodate data cable termination (3+1 facing front, 3+1 facing back) • Includes 2 metal covers with 4 duplex outlet holes.

Top Mount End Panels and Shared Top Mount End Panels

TOP MOUNT END PANELS

D	H	Model Number	List
18	21	C-CEP1821	266
18	29	C-CEP1829	334
18	42	C-CEP1842	401
18	46	C-CEP1846	417
24	21	C-CEP2421	411
24	29	C-CEP2429	479
24	42	C-CEP2442	546
24	46	C-CEP2446	561
30	21	C-CEP3021	556
30	29	C-CEP3029	624
30	42	C-CEP3042	696
30	46	C-CEP3046	712
36	21	C-CEP3621	701
36	29	C-CEP3629	768
36	42	C-CEP3642	841
36	46	C-CEP3646	856



24D x 29H Shown

SHARED TOP MOUNT END PANELS

D	H	Model Number	List
18	21	C-CEPTS1821	266
18	29	C-CEPTS1829	334
18	42	C-CEPTS1842	401
18	46	C-CEPTS1846	417
24	21	C-CEPTS2421	411
24	29	C-CEPTS2429	479
24	42	C-CEPTS2442	546
24	46	C-CEPTS2446	561
30	21	C-CEPTS3021	556
30	29	C-CEPTS3029	624
30	42	C-CEPTS3042	696
30	46	C-CEPTS3046	712
36	21	C-CEPTS3621	701
36	29	C-CEPTS3629	768
36	42	C-CEPTS3642	841
36	46	C-CEPTS3646	856

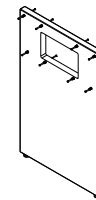

24D x 29H Shown

Specify

Notes

- Laminite Selection
- Top Mount End Panel supports one end of spine at top of end panel and overlays the end of the spine.
- Top Mount End Panels add 1 1/8" to end of spine.
- Specify the end panel that matches spine depth.

Specify

Notes

- Laminite Selection
- Shared Top Mount End Panel supports the end of 2 spines at top of end panel and adds 1 1/8" to length of spine.
- Specify the end panel that matches spine depth.
- Shared Top Mount End Panels have center cutouts to accommodate running electrical and data cables.

Mid Mount End Panels

MID MOUNT END PANELS					MID MOUNT END PANELS				
D	Overall H	Spine Mount H	Model Number	List	D	Overall H	Spine Mount H	Model Number	List
18	42	12	C-CEP184221	401	30	42	21	C-CEP304221	624
18	42	29	C-CEP184229	401	30	42	29	C-CEP304229	624
18	46	21	C-CEP184621	417	30	46	21	C-CEP304621	712
18	46	29	C-CEP184629	417	30	46	29	C-CEP304629	712
18	50	21	C-CEP185021	433	30	50	21	C-CEP305021	728
18	50	29	C-CEP185029	433	30	50	29	C-CEP305029	728
18	50	42	C-CEP185042	433	30	50	42	C-CEP305042	728
18	58	21	C-CEP185821	464	30	58	21	C-CEP305821	770
18	58	29	C-CEP185829	464	30	58	29	C-CEP305829	770
18	58	42	C-CEP185842	464	30	58	42	C-CEP305842	770
18	66	21	C-CEP186621	495	30	66	21	C-CEP306621	811
18	66	29	C-CEP186629	495	30	66	29	C-CEP306629	811
18	66	42	C-CEP186642	495	30	66	42	C-CEP306642	811
24	42	21	C-CEP244221	546	36	42	21	C-CEP364221	768
24	42	29	C-CEP244229	546	36	42	29	C-CEP364229	768
24	46	21	C-CEP244621	561	36	46	21	C-CEP364621	856
24	46	29	C-CEP244629	561	36	46	29	C-CEP364629	856
24	50	21	C-CEP245021	578	36	50	21	C-CEP365021	873
24	50	29	C-CEP245029	578	36	50	29	C-CEP365029	873
24	50	42	C-CEP245042	578	36	50	42	C-CEP365042	873
24	58	21	C-CEP245821	619	36	58	21	C-CEP365821	925
24	58	29	C-CEP245829	619	36	58	29	C-CEP365829	925
24	58	42	C-CEP245842	619	36	58	42	C-CEP365842	925
24	66	21	C-CEP246621	661	36	66	21	C-CEP366621	977
24	66	29	C-CEP246629	661	36	66	29	C-CEP366629	977
24	66	42	C-CEP246642	661	36	66	42	C-CEP366642	977



42H x 18D x 29H Mount Height Shown

Specify	Notes
• Laminate Selection	• Mid Mount End Panel supports one end of spine at various height with a section of end panel above spine mounting height to act as a finished end for storage or screens or to create a space for adjacent gallery panels and rolling whiteboards. • End panel overlays end of spine and adds 1 1/8" to spine. • Specify the end panel that matches the spine depth.

Shared Mid Mount End Panels

SHARED MID MOUNT END PANELS				
D	Overall H	Spine Mount H	Model Number	List
18	29	21	C-CEPMS182921	334
18	42	21	C-CEPMS184221	401
18	42	29	C-CEPMS184229	401
18	46	21	C-CEPMS184621	417
18	46	29	C-CEPMS184629	417
18	50	21	C-CEPMS185021	433
18	50	29	C-CEPMS185029	433
18	50	42	C-CEPMS185042	433
18	58	21	C-CEPMS185821	464
18	58	29	C-CEPMS185829	464
18	58	42	C-CEPMS185842	464
18	58	46	C-CEPMS185846	464
18	66	21	C-CEPMS186621	495
18	66	29	C-CEPMS186629	495
18	66	42	C-CEPMS186642	495
18	66	46	C-CEPMS186646	495

SHARED MID MOUNT END PANELS				
D	Overall H	Spine Mount H	Model Number	List
24	29	21	C-CEPMS242921	479
24	42	21	C-CEPMS244221	546
24	42	29	C-CEPMS244229	546
24	46	21	C-CEPMS244621	561
24	46	29	C-CEPMS244629	561
24	50	21	C-CEPMS245021	578
24	50	29	C-CEPMS245029	578
24	50	42	C-CEPMS245042	578
24	58	21	C-CEPMS245821	619
24	58	29	C-CEPMS245829	619
24	58	42	C-CEPMS245842	619
24	58	46	C-CEPMS245846	619
24	66	21	C-CEPMS246621	661
24	66	29	C-CEPMS246629	661
24	66	42	C-CEPMS246642	661
24	66	46	C-CEPMS246646	661

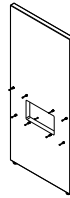

Specify

- Laminate Selection

Notes

- Shared Mid Mount End Panel supports the ends of 2 spines at various matching heights with a section of panel above spine mounting height to act as a finished end for storage or screens or to create a space for adjacent gallery panels and rolling whiteboards.
- Shared Mid Mount End Panel adds 1 1/8" to length of spine overall.
- Shared Mid Mount End Panels have center cutouts to accommodate running electrical and data cables.
- Specify the end panel that matches the spine depth.

Shared Mid Mount End Panels

SHARED MID MOUNT END PANELS				
D	Overall H	Spine Mount H	Model Number	List
30	29	21	C-CEPMS302921	624
30	42	21	C-CEPMS304221	696
30	42	29	C-CEPMS304229	696
30	46	21	C-CEPMS304621	712
30	46	29	C-CEPMS304629	712
30	50	21	C-CEPMS305021	728
30	50	29	C-CEPMS305029	728
30	50	42	C-CEPMS305042	728
30	58	21	C-CEPMS305821	770
30	58	29	C-CEPMS305829	770
30	58	42	C-CEPMS305842	770
30	58	46	C-CEPMS305846	770
30	66	21	C-CEPMS306621	811
30	66	29	C-CEPMS306629	811
30	66	42	C-CEPMS306642	811
30	66	46	C-CEPMS306646	811

SHARED MID MOUNT END PANELS				
D	Overall H	Spine Mount H	Model Number	List
36	29	21	C-CEPMS362921	768
36	42	21	C-CEPMS364221	841
36	42	29	C-CEPMS364229	841
36	46	21	C-CEPMS364621	856
36	46	29	C-CEPMS364629	856
36	50	21	C-CEPMS365021	873
36	50	29	C-CEPMS365029	873
36	50	42	C-CEPMS365042	873
36	58	21	C-CEPMS365821	925
36	58	29	C-CEPMS365829	925
36	58	42	C-CEPMS365842	925
36	58	46	C-CEPMS365846	925
36	66	21	C-CEPMS366621	977
36	66	29	C-CEPMS366629	977
36	66	42	C-CEPMS366642	977
36	66	46	C-CEPMS366646	977

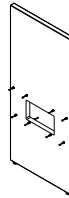

Specify

- Laminate Selection

Notes

- Shared Mid Mount End Panel supports the ends of 2 spines at various matching heights with a section of panel above spine mounting height to act as a finished end for storage or screens or to create a space for adjacent gallery panels and rolling whiteboards.
- Shared Mid Mount End Panel adds 1 1/8" to length of spine overall.
- Shared Mid Mount End Panels have center cutouts to accommodate running electrical and data cables.
- Specify the end panel that matches the spine depth.

Offset Shared End Panels

OFFSET SHARED END PANELS				
D	Overall H	Lower Spine Mount H	Model Number	List
18	29	21	C-CEPS182921	334
18	42	21	C-CEPS184221	401
18	46	21	C-CEPS184621	417
18	46	29	C-CEPS184629	417
24	29	21	C-CEPS242921	479
24	42	21	C-CEPS244221	546
24	42	29	C-CEPS244229	546
24	46	21	C-CEPS244621	561
24	46	29	C-CEPS244629	561

OFFSET SHARED END PANELS				
D	Overall H	Lower Spine Mount H	Model Number	List
30	29	21	C-CEPS302921	624
30	42	21	C-CEPS304221	696
30	42	29	C-CEPS304229	696
30	46	21	C-CEPS304621	712
30	46	29	C-CEPS304629	712
36	29	21	C-CEPS362921	768
36	42	21	C-CEPS364221	841
36	42	29	C-CEPS364229	841
36	46	21	C-CEPS364621	856
36	46	29	C-CEPS364629	856

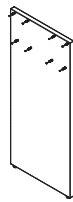

Front View
42H x 18D with 21H Lower
Mount Height Shown

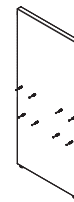

Back View
42H x 18D with 21H Lower
Mount Height Shown

Specify

- Laminate Selection

Notes

- Offset Shared End Panel supports the ends of 2 spines at various offset heights with one spine mounted at top and one spine mounted lower.
- Offset Shared End Panel adds 1 1/8" to length of spine overall.
- Offset Shared End Panel DO NOT accommodate electrical and data cable transition without field modifications.
- Specify the end panel that matches the spine depth.

Mid Supports and Infeed Base Supports

MID SUPPORTS

D	H	For Use With	Model Number	List
18	13	21 High	C-CMSP1821	234
18	21	29 High	C-CMSP1829	266
24	21	21 High	C-CMSP2421	379
24	29	29 High	C-CMSP2429	411
30	13	21 High	C-CMSP3021	524
30	21	29 High	C-CMSP3029	556
36	13	21 High	C-CMSP3621	669
36	21	29 High	C-CMSP3629	701

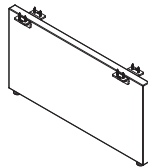

Specify	Notes
<ul style="list-style-type: none"> Laminate Selection 	<ul style="list-style-type: none"> Mid Supports are used to support 2 adjacent spines at 21" or 29" high. Mid Supports sit "under" spines and do not add dimension to spine run.

INFEEED BASE SUPPORT

D	W	H	Model Number	List
18	6	13	C-CIBS180613	880
18	6	21	C-CIBS180621	906
18	12	13	C-CIBS181213	963
18	12	21	C-CIBS181221	1,046
24	6	13	C-CIBS240613	984
24	6	21	C-CIBS240621	1,010
24	12	13	C-CIBS241213	1,067
24	12	21	C-CIBS241221	1,149
30	6	13	C-CIBS300613	1,087
30	6	21	C-CIBS300621	1,113
30	12	13	C-CIBS301213	1,170
30	12	21	C-CIBS301221	1,253
36	6	13	C-CIBS360613	1,191
36	6	21	C-CIBS360621	1,217
36	12	13	C-CIBS361213	1,274
36	12	21	C-CIBS361221	1,356

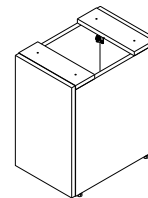

Specify	Notes
<ul style="list-style-type: none"> Laminate Selection 	<ul style="list-style-type: none"> Infeed Base supports may be used to support 21" or 29" high spines as well as allow for transition of electrical and data cables from a floor core to spine. Infeed Base Supports have removable front and back panels and an open bottom to accommodate access to floor cores. Order support that matches spine depth. Supports are 6" or 12" wide and should be planned with adjacent storage elements appropriately.

Fixed Run-Offs

**FIXED RUN-OFFS
(2MM EDGE WITH TAPERED LEGS)**

H	W	D	Model Number	List
29	36	24	X-DROR2436T	1,300
29	42	24	X-DROR2442T	1,336
29	48	24	X-DROR2448T	1,371
29	54	24	X-DROR2454T	1,406
29	60	24	X-DROR2460T	1,441
29	66	24	X-DROR2466T	1,478
29	72	24	X-DROR2472T	1,512
29	78	24	X-DROR2478T	1,546
29	84	24	X-DROR2484T	1,581
29	36	30	X-DROR3036T	1,352
29	42	30	X-DROR3042T	1,387
29	48	30	X-DROR3048T	1,423
29	54	30	X-DROR3054T	1,458
29	60	30	X-DROR3060T	1,493
29	66	30	X-DROR3066T	1,530
29	72	30	X-DROR3072T	1,563
29	78	30	X-DROR3078T	1,598
29	84	30	X-DROR3084T	1,633

**FIXED RUN-OFFS
(KNIFE EDGE WITH TAPERED LEGS)**

H	W	D	Model Number	List
29	36	24	X-DROK2436T	2,495
29	42	24	X-DROK2442T	2,530
29	48	24	X-DROK2448T	2,565
29	54	24	X-DROK2454T	2,600
29	60	24	X-DROK2460T	2,616
29	66	24	X-DROK2466T	2,661
29	72	24	X-DROK2472T	2,691
29	78	24	X-DROK2478T	2,755
29	84	24	X-DROK2484T	2,771
29	36	30	X-DROK3036T	2,547
29	42	30	X-DROK3042T	2,582
29	48	30	X-DROK3048T	2,617
29	54	30	X-DROK3054T	2,652
29	60	30	X-DROK3060T	2,668
29	66	30	X-DROK3066T	2,713
29	72	30	X-DROK3072T	2,743
29	78	30	X-DROK3078T	2,806
29	84	30	X-DROK3084T	2,823

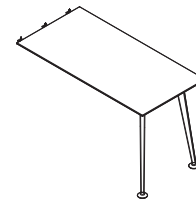
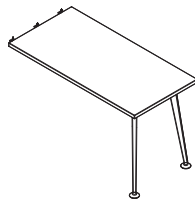

Specify

Notes

- Laminate Selection for Worksurface
- Color Selection for Leg
- Color Selection for Edge
- Grommet Option and Color

- Fixed Run-off tables are designed for long side to mount perpendicular to 29" high spines in a fixed manner.
- Fixed Run-off table mounting does not impede flip door or electrical access.
- Fixed Run-off tables may be ordered with grommets on short or long sides.

Sliding Run-Offs

SLIDING RUN-OFFS (2MM EDGE WITH TAPERED LEGS)						
H	W	D	With Glides		With Caster	
			Model Number	List	Model Number	List
29	36	24	C-CSRR2436G	1,352	C-CSRR2436C	1,399
29	42	24	C-CSRR2442G	1,387	C-CSRR2442C	1,434
29	48	24	C-CSRR2448G	1,423	C-CSRR2448C	1,469
29	54	24	C-CSRR2454G	1,458	C-CSRR2454C	1,504
29	60	24	C-CSRR2460G	1,493	C-CSRR2460C	1,540
29	66	24	C-CSRR2466G	1,530	C-CSRR2466C	1,577
29	72	24	C-CSRR2472G	1,563	C-CSRR2472C	1,610
29	78	24	C-CSRR2478G	1,598	C-CSRR2478C	1,644
29	84	24	C-CSRR2484G	1,633	C-CSRR2484C	1,679
29	36	30	C-CSRR3036G	1,404	C-CSRR3036C	1,451
29	42	30	C-CSRR3042G	1,439	C-CSRR3042C	1,486
29	48	30	C-CSRR3048G	1,474	C-CSRR3048C	1,521
29	54	30	C-CSRR3054G	1,510	C-CSRR3054C	1,556
29	60	30	C-CSRR3060G	1,545	C-CSRR3060C	1,591
29	66	30	C-CSRR3066G	1,582	C-CSRR3066C	1,629
29	72	30	C-CSRR3072G	1,615	C-CSRR3072C	1,662
29	78	30	C-CSRR3078G	1,649	C-CSRR3078C	1,696
29	84	30	C-CSRR3084G	1,684	C-CSRR3084C	1,731

SLIDING RUN-OFFS (KNIFE EDGE WITH TAPERED LEGS)						
H	W	D	With Glides		With Caster	
			Model Number	List	Model Number	List
29	36	24	C-CSRK2436G	2,547	C-CSRK2436C	2,593
29	42	24	C-CSRK2442G	2,582	C-CSRK2442C	2,628
29	48	24	C-CSRK2448G	2,617	C-CSRK2448C	2,664
29	54	24	C-CSRK2454G	2,652	C-CSRK2454C	2,699
29	60	24	C-CSRK2460G	2,668	C-CSRK2460C	2,714
29	66	24	C-CSRK2466G	2,713	C-CSRK2466C	2,760
29	72	24	C-CSRK2472G	2,743	C-CSRK2472C	2,790
29	78	24	C-CSRK2478G	2,806	C-CSRK2478C	2,853
29	84	24	C-CSRK2484G	2,823	C-CSRK2484C	2,870
29	36	30	C-CSRK3036G	2,598	C-CSRK3036C	2,645
29	42	30	C-CSRK3042G	2,634	C-CSRK3042C	2,680
29	48	30	C-CSRK3048G	2,669	C-CSRK3048C	2,715
29	54	30	C-CSRK3054G	2,704	C-CSRK3054C	2,750
29	60	30	C-CSRK3060G	2,719	C-CSRK3060C	2,766
29	66	30	C-CSRK3066G	2,765	C-CSRK3066C	2,812
29	72	30	C-CSRK3072G	2,795	C-CSRK3072C	2,842
29	78	30	C-CSRK3078G	2,858	C-CSRK3078C	2,905
29	84	30	C-CSRK3084G	2,875	C-CSRK3084C	2,921

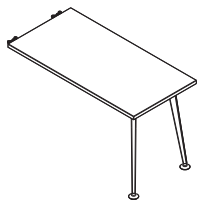

On Glides

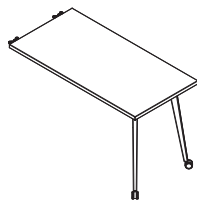

On Casters

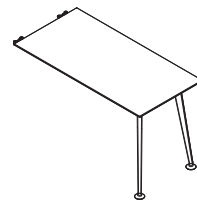

On Glides

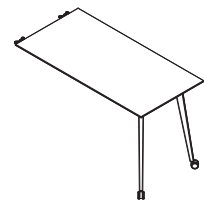

On Casters

Specify

- Laminate Selection for Worksurface
- Color Selection for Leg
- Color Selection for Edge
- Grommet Option and Color

Notes

- Sliding Run-off tables are designed for the long side to mount perpendicular to 29 high spines that have Sliding Run-off Tracks which can be ORDERED SEPARATELY for any spine length.
- Sliding Run-offs can be ordered with casters for tables often being moved, or with glides for tables that are seldom moved.
- Sliding Run-offs with glides must be lifted slightly at end with legs to slide.
- Sliding Run-off table mounting DOES NOT impede flip door or electrical access.
- Sliding Run-off tables may be ordered with grommets on short or long sides.
- Sliding Run-off tables can slide between tracks on adjacent spines.

SLIDING RUN-OFF TRACKS

W	Model Number	List
24	C-CRRT24	139
30	C-CRRT30	156
36	C-CRRT36	173
42	C-CRRT42	191
48	C-CRRT48	207
54	C-CRRT54	225
60	C-CRRT60	243
66	C-CRRT66	207
72	C-CRRT72	225
78	C-CRRT78	294
84	C-CRRT84	311
90	C-CRRT90	329
96	C-CRRT96	346

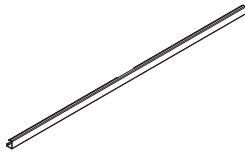

Specify	Notes
<ul style="list-style-type: none"> • Paint Selection 	<ul style="list-style-type: none"> • Sliding Run-off Tracks can be mounted to front and back of any spine to accommodate sliding run-off surfaces. • Each track is sold separately for one side of a spine. • Order track that corresponds to the complete length of the spine. • Tracks are visible behind power cord access gap and can be paint the color of choosing.

Fixed Spine Surfaces

**FIXED SPINE SURFACES
(2MM EDGE WITH TAPERED LEGS)**

H	W	D	Model Number	List
29	36	18	X-DROR1836TS	1,300
29	42	18	X-DROR1842TS	1,336
29	48	18	X-DROR1848TS	1,371
29	54	18	X-DROR1854TS	1,406
29	60	18	X-DROR1860TS	1,441
29	66	18	X-DROR1866TS	1,478
29	72	18	X-DROR1872TS	1,512
29	78	18	X-DROR1878TS	1,546
29	84	18	X-DROR1884TS	1,581
29	36	24	X-DROR2436TS	1,300
29	42	24	X-DROR2442TS	1,336
29	48	24	X-DROR2448TS	1,371
29	54	24	X-DROR2454TS	1,406
29	60	24	X-DROR2460TS	1,441
29	66	24	X-DROR2466TS	1,478
29	72	24	X-DROR2472TS	1,512
29	78	24	X-DROR2478TS	1,546
29	84	24	X-DROR2484TS	1,581
29	36	30	X-DROR3036TS	1,352
29	42	30	X-DROR3042TS	1,387
29	48	30	X-DROR3048TS	1,423
29	54	30	X-DROR3054TS	1,458
29	60	30	X-DROR3060TS	1,493
29	66	30	X-DROR3066TS	1,530
29	72	30	X-DROR3072TS	1,563
29	78	30	X-DROR3078TS	1,598
29	84	30	X-DROR3084TS	1,633

**FIXED SPINE SURFACES
(KNIFE EDGE WITH TAPERED LEGS)**

H	W	D	Model Number	List
29	36	18	X-DROK1836TS	2,495
29	42	18	X-DROK1842TS	2,530
29	48	18	X-DROK1848TS	2,565
29	54	18	X-DROK1854TS	2,600
29	60	18	X-DROK1860TS	2,616
29	66	18	X-DROK1866TS	2,661
29	72	18	X-DROK1872TS	2,691
29	78	18	X-DROK1878TS	2,755
29	84	18	X-DROK1884TS	2,771
29	36	24	X-DROK2436TS	2,495
29	42	24	X-DROK2442TS	2,530
29	48	24	X-DROK2448TS	2,565
29	54	24	X-DROK2454TS	2,600
29	60	24	X-DROK2460TS	2,616
29	66	24	X-DROK2466TS	2,661
29	72	24	X-DROK2472TS	2,691
29	78	24	X-DROK2478TS	2,755
29	84	24	X-DROK2484TS	2,771
29	36	30	X-DROK3036TS	2,495
29	42	30	X-DROK3042TS	2,530
29	48	30	X-DROK3048TS	2,565
29	54	30	X-DROK3054TS	2,600
29	60	30	X-DROK3060TS	2,616
29	66	30	X-DROK3066TS	2,661
29	72	30	X-DROK3072TS	2,691
29	78	30	X-DROK3078TS	2,755
29	84	30	X-DROK3084TS	2,771

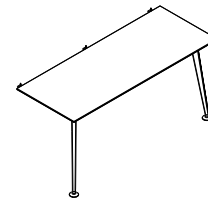
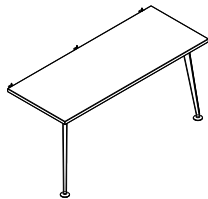

Specify

Notes

- Laminate Selection for Worksurface
- Color Selection for Leg
- Color Selection for Edge
- Grommet Option and Color

- Fixed Spine Surfaces are designed for long side to mount PARALLEL to 29 high spines in a fixed manner.
- Fixed Spine Surface mounting does not impede flip door or electrical access.
- Fixed Spine Surfaces may be ordered with grommets on long sides.

Cantilevered Spine Surfaces

CANTILEVERED SPINE SURFACES (2MM EDGE)

CANTILEVERED SPINE SURFACES (KNIFE EDGE)

H	W	D	Model Number	List
29	36	18	C-CCSSR1836	1,300
29	42	18	C-CCSSR1842	1,336
29	48	18	C-CCSSR1848	1,371
29	54	18	C-CCSSR1854	1,406
29	60	18	C-CCSSR1860	1,441
29	66	18	C-CCSSR1866	1,478
29	72	18	C-CCSSR1872	1,512

H	W	D	Model Number	List
29	36	18	C-CCSSK1836	2,495
29	42	18	C-CCSSK1842	2,530
29	48	18	C-CCSSK1848	2,565
29	54	18	C-CCSSK1854	2,600
29	60	18	C-CCSSK1860	2,616
29	66	18	C-CCSSK1866	2,661
29	72	18	C-CCSSK1872	2,691

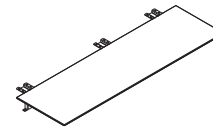
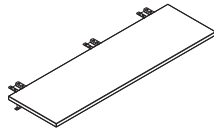

Specify

Notes

- Laminate Selection for Worksurface
- Color Selection for Leg
- Color Selection for Edge
- Color Selection for Cantilevers
- Grommet Option and Color

- Cantilevered Spine Surfaces mount to spine cabinets supported by storage elements. See guidelines in product details.
- Cantilevered Spine Surfaces DO NOT impede flip door access.
- Cantilevered Spine Surfaces can be ordered with Grommets on long side.

Stack-On Desks

STACK-ON DESKS					
H	W	D	Left Modesty	Right Modesty	List
			Model Number	Model Number	
29	42	24	X-SODL284224	X-SODR284224	864
29	48	24	X-SODL284824	X-SODR284824	893
29	54	24	X-SODL285424	X-SODR285424	908
29	60	24	X-SODL286024	X-SODR286024	948
29	66	24	X-SODL286624	X-SODR286624	980
29	72	24	X-SODL287224	X-SODR287224	1,007
29	78	24	X-SODL287824	X-SODR287824	1,035
29	84	24	X-SODL288424	X-SODR288424	1,064
29	42	30	X-SODL284230	X-SODR284230	933
29	48	30	X-SODL284830	X-SODR284830	965
29	54	30	X-SODL285430	X-SODR285430	998
29	60	30	X-SODL286030	X-SODR286030	1,030
29	66	30	X-SODL286630	X-SODR286630	1,064
29	72	30	X-SODL287230	X-SODR287230	1,099
29	78	30	X-SODL287830	X-SODR287830	1,131
29	84	30	X-SODL288430	X-SODR288430	1,165

CENTERED MODESTY STACK-ON DESKS					
H	W	D	Model Number	List	
29	42	36	X-SODM284236	974	
29	48	36	X-SODM284836	1,040	
29	54	36	X-SODM285436	1,077	
29	60	36	X-SODM286036	1,113	
29	66	36	X-SODM286636	1,151	
29	72	36	X-SODM287236	1,189	
29	78	36	X-SODM287836	1,226	
29	84	36	X-SODM288436	1,263	

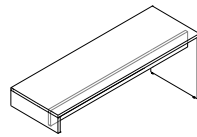

Left Modesty

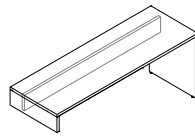

Right Modesty

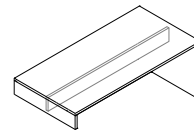

Center Modesty

Specify

- Laminate Selection for Worksurface
- Laminate Selection for Case

Notes

- Stack on Desks are designed to be stacked ON 21" HIGH SPINES ONLY to serve as run-off desks perpendicular to spines.
- Available in Left, Right or with Centered modesty on deeper sizes.
- Modesty on handed units are recessed 4 inches leaving knee space of 18 inches on 24d and 24 inches on 30d.

SPINE HUTCH F (18" DEEP)					SPINE HUTCH F (24" DEEP)				
H	W	D	Model Number	List	H	W	D	Model Number	List
12	24	18	C-CSH122418F	916	12	24	24	C-CSH122424F	994
12	30	18	C-CSH123018F	969	12	30	24	C-CSH123024F	1,059
12	36	18	C-CSH123618F	1,163	12	36	24	C-CSH123624F	1,281
12	42	18	C-CSH124218F	1,214	12	42	24	C-CSH124224F	1,344
12	48	18	C-CSH124818F	1,271	12	48	24	C-CSH124824F	1,414
12	54	18	C-CSH125418F	1,322	12	54	24	C-CSH125424F	1,478
12	60	18	C-CSH126018F	1,376	12	60	24	C-CSH126024F	1,545
12	66	18	C-CSH126618F	1,523	12	66	24	C-CSH126624F	1,704
12	72	18	C-CSH127218F	1,573	12	72	24	C-CSH127224F	1,767
16	24	18	C-CSH162418F	958	16	24	24	C-CSH162424F	1,044
16	30	18	C-CSH163018F	1,015	16	30	24	C-CSH163024F	1,113
16	36	18	C-CSH163618F	1,225	16	36	24	C-CSH163624F	1,355
16	42	18	C-CSH164218F	1,280	16	42	24	C-CSH164224F	1,424
16	48	18	C-CSH164818F	1,342	16	48	24	C-CSH164824F	1,498
16	54	18	C-CSH165418F	1,397	16	54	24	C-CSH165424F	1,565
16	60	18	C-CSH166018F	1,455	16	60	24	C-CSH166024F	1,637
16	66	18	C-CSH166618F	1,606	16	66	24	C-CSH166624F	1,800
16	72	18	C-CSH167218F	1,661	16	72	24	C-CSH167224F	1,868
20	24	18	C-CSH202418F	1,002	20	24	24	C-CSH202424F	1,098
20	30	18	C-CSH203018F	1,063	20	30	24	C-CSH203024F	1,171
20	36	18	C-CSH203618F	1,292	20	36	24	C-CSH203624F	1,435
20	42	18	C-CSH204218F	1,350	20	42	24	C-CSH204224F	1,506
20	48	18	C-CSH204818F	1,417	20	48	24	C-CSH204824F	1,586
20	54	18	C-CSH205418F	1,475	20	54	24	C-CSH205424F	1,658
20	60	18	C-CSH206018F	1,539	20	60	24	C-CSH206024F	1,733
20	66	18	C-CSH206618F	1,694	20	66	24	C-CSH206624F	1,901
20	72	18	C-CSH207218F	1,753	20	72	24	C-CSH207224F	1,972

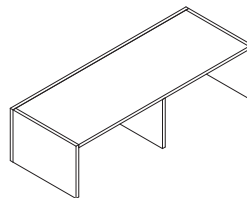

Specify

- Laminate Selection

Notes

- Provides storage and space division facing one side only.
- Full finished back.
- Unit provided with rubber high friction strips for retention.

Spine Hutch F

SPINE HUTCH F (18" DEEP)

H	W	D	Model Number	List
28	24	18	C-CSH282418F	1,112
28	30	18	C-CSH283018F	1,359
28	36	18	C-CSH283618F	1,421
28	42	18	C-CSH284218F	1,493
28	48	18	C-CSH284818F	1,554
28	54	18	C-CSH285418F	1,622
28	60	18	C-CSH286018F	1,782
28	66	18	C-CSH286618F	1,845
28	72	18	C-CSH287218F	1,161
36	24	18	C-CSH362418F	1,427
36	30	18	C-CSH363018F	1,491
36	36	18	C-CSH363618F	1,569
36	42	18	C-CSH364218F	1,633
36	48	18	C-CSH364818F	1,706
36	54	18	C-CSH365418F	1,870
36	60	18	C-CSH366018F	1,937
36	66	18	C-CSH366618F	1,161
36	72	18	C-CSH367218F	1,427

SPINE HUTCH F (24" DEEP)

H	W	D	Model Number	List
28	24	24	C-CSH282424F	1,151
28	30	24	C-CSH283024F	1,229
28	36	24	C-CSH283624F	1,515
28	42	24	C-CSH284224F	1,589
28	48	24	C-CSH284824F	1,674
28	54	24	C-CSH285424F	1,750
28	60	24	C-CSH286024F	1,829
28	66	24	C-CSH286624F	2,001
28	72	24	C-CSH287224F	2,077
36	24	24	C-CSH362424F	1,205
36	30	24	C-CSH363024F	1,287
36	36	24	C-CSH363624F	1,594
36	42	24	C-CSH364224F	1,672
36	48	24	C-CSH364824F	1,762
36	54	24	C-CSH365424F	1,842
36	60	24	C-CSH366024F	1,926
36	66	24	C-CSH366624F	2,102
36	72	24	C-CSH367224F	2,181

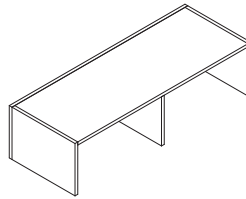

Specify

- Laminate Selection

Notes

- Provides storage and space division facing one side only.
- Full finished back.
- Unit provided with rubber high friction strips for retention.

SPINE HUTCH G (18" DEEP)

H	W	D	Model Number	List
20	24	18	C-CSH202418G	1,293
20	30	18	C-CSH203018G	1,378
20	36	18	C-CSH203618G	1,587
20	42	18	C-CSH204218G	1,661
20	48	18	C-CSH204818G	1,746
20	54	18	C-CSH205418G	1,918
20	60	18	C-CSH206018G	2,000
20	66	18	C-CSH206618G	2,085
20	72	18	C-CSH207218G	2,258
20	78	18	C-CSH207818G	2,339
20	84	18	C-CSH208418G	2,420

SPINE HUTCH G (24" DEEP)

H	W	D	Model Number	List
20	24	24	C-CSH202424G	1,422
20	30	24	C-CSH203024G	1,526
20	36	24	C-CSH203624G	1,763
20	42	24	C-CSH204224G	1,856
20	48	24	C-CSH204824G	1,962
20	54	24	C-CSH205424G	2,155
20	60	24	C-CSH206024G	2,257
20	66	24	C-CSH206624G	2,361
20	72	24	C-CSH207224G	2,555
20	78	24	C-CSH207824G	2,656
20	84	24	C-CSH208424G	2,758

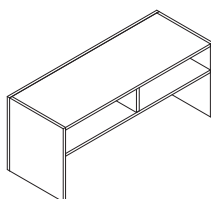

Specify

- Laminate Selection

Notes

- Provides storage and space division facing one side only.
- Full finished back.
- 20" high unit has 8" high cubby above.
- Unit provided with rubber high friction strips for retention.

Spine Hutch G

SPINE HUTCH G WITH 8" HIGH CUBBY SHELF (18" DEEP)

H	W	D	Cubby H	Model Number	List
28	24	18	8	C-CSH282418G8	1,388
28	30	18	8	C-CSH283018G8	1,483
28	36	18	8	C-CSH283618G8	1,697
28	42	18	8	C-CSH284218G8	1,779
28	48	18	8	C-CSH284818G8	1,873
28	54	18	8	C-CSH285418G8	2,055
28	60	18	8	C-CSH286018G8	2,145
28	66	18	8	C-CSH286618G8	2,239
28	72	18	8	C-CSH287218G8	2,421
28	78	18	8	C-CSH287818G8	2,511
28	84	18	8	C-CSH288418G8	2,601

SPINE HUTCH G WITH 8" HIGH CUBBY SHELF (24" DEEP)

H	W	D	Cubby H	Model Number	List
28	24	24	8	C-CSH282424G8	1,531
28	30	24	8	C-CSH283024G8	1,645
28	36	24	8	C-CSH283624G8	1,890
28	42	24	8	C-CSH284224G8	1,993
28	48	24	8	C-CSH284824G8	2,108
28	54	24	8	C-CSH285424G8	2,310
28	60	24	8	C-CSH286024G8	2,420
28	66	24	8	C-CSH286624G8	2,534
28	72	24	8	C-CSH287224G8	2,737
28	78	24	8	C-CSH287824G8	2,847
28	84	24	8	C-CSH288424G8	2,957

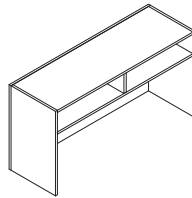

Specify

- Laminate Selection

Notes

- Provides storage and space division facing one side only.
- Full finished back.
- 28" high unit has 8" or 16" high cubby above.
- Unit provided with rubber high friction strips for retention.

SPINE HUTCH G WITH 16" HIGH CUBBY SHELF (18" DEEP)

SPINE HUTCH G WITH 16" HIGH CUBBY SHELF (24" DEEP)

H	W	D	Cubby H	Model Number	List
28	24	18	16	C-CSH282418G16	1,384
28	30	18	16	C-CSH283018G16	1,478
28	36	18	16	C-CSH283618G16	1,722
28	42	18	16	C-CSH284218G16	1,805
28	48	18	16	C-CSH284818G16	1,898
28	54	18	16	C-CSH285418G16	2,081
28	60	18	16	C-CSH286018G16	2,171
28	66	18	16	C-CSH286618G16	2,264
28	72	18	16	C-CSH287218G16	2,446
28	78	18	16	C-CSH287818G16	2,536
28	84	18	16	C-CSH288418G16	2,626
36	24	18	16	C-CSH362418G16	1,504
36	30	18	16	C-CSH363018G16	1,608
36	36	18	16	C-CSH363618G16	1,856
36	42	18	16	C-CSH364218G16	1,947
36	48	18	16	C-CSH364818G16	2,050
36	54	18	16	C-CSH365418G16	2,242
36	60	18	16	C-CSH366018G16	2,341
36	66	18	16	C-CSH366618G16	2,443
36	72	18	16	C-CSH367218G16	2,635
36	78	18	16	C-CSH367818G16	2,734
36	84	18	16	C-CSH368418G16	2,832

H	W	D	Cubby H	Model Number	List
28	24	24	16	C-CSH282424G16	1,531
28	30	24	16	C-CSH283024G16	1,645
28	36	24	16	C-CSH283624G16	1,925
28	42	24	16	C-CSH284224G16	2,028
28	48	24	16	C-CSH284824G16	2,142
28	54	24	16	C-CSH285424G16	2,344
28	60	24	16	C-CSH286024G16	2,454
28	66	24	16	C-CSH286624G16	2,568
28	72	24	16	C-CSH287224G16	2,771
28	78	24	16	C-CSH287824G16	2,881
28	84	24	16	C-CSH288424G16	2,992
36	24	24	16	C-CSH362424G16	1,675
36	30	24	16	C-CSH363024G16	1,798
36	36	24	16	C-CSH363624G16	2,086
36	42	24	16	C-CSH364224G16	2,199
36	48	24	16	C-CSH364824G16	2,322
36	54	24	16	C-CSH365424G16	2,532
36	60	24	16	C-CSH366024G16	2,652
36	66	24	16	C-CSH366624G16	2,775
36	72	24	16	C-CSH367224G16	2,988
36	78	24	16	C-CSH367824G16	3,105
36	84	24	16	C-CSH368424G16	3,226

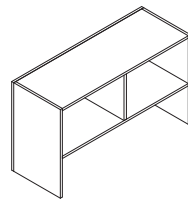

Specify

Notes

• Laminate Selection

- Provides storage and space division facing one side only.
- Full finished back.
- 28" high unit has 8" or 16" high cubby above.
- Unit provided with rubber high friction strips for retention.

Spine Hutch J

SPINE HUTCH J (18" DEEP)					
H	W	D	Cabinet Left		List
			Model Number	Model Number	
20	60	18	C-CSH206018JL	C-CSH206018J	2,509
20	66	18	C-CSH206618JL	C-CSH206618J	2,563
20	72	18	C-CSH207218JL	C-CSH207218J	2,622
20	78	18	C-CSH207818JL	C-CSH207818J	2,710
20	84	18	C-CSH208418JL	C-CSH208418J	2,768
28	60	18	C-CSH286018JL	C-CSH286018J	2,752
28	66	18	C-CSH286618JL	C-CSH286618J	2,815
28	72	18	C-CSH287218JL	C-CSH287218J	2,882
28	78	18	C-CSH287818JL	C-CSH287818J	2,989
28	84	18	C-CSH288418JL	C-CSH288418J	3,055
36	60	18	C-CSH366018JL	C-CSH366018J	2,994
36	66	18	C-CSH366618JL	C-CSH366618J	3,066
36	72	18	C-CSH367218JL	C-CSH367218J	3,142
36	78	18	C-CSH367818JL	C-CSH367818J	3,267
36	84	18	C-CSH368418JL	C-CSH368418J	3,341

SPINE HUTCH J (24" DEEP)					
H	W	D	Cabinet Left		List
			Model Number	Model Number	
20	60	24	C-CSH206024JL	C-CSH206024J	2,710
20	66	24	C-CSH206624JL	C-CSH206624J	2,777
20	72	24	C-CSH207224JL	C-CSH207224J	2,848
20	78	24	C-CSH207824JL	C-CSH207824J	2,949
20	84	24	C-CSH208424JL	C-CSH208424J	3,020
28	60	24	C-CSH286024JL	C-CSH286024J	2,978
28	66	24	C-CSH286624JL	C-CSH286624J	3,054
28	72	24	C-CSH287224JL	C-CSH287224J	3,133
28	78	24	C-CSH287824JL	C-CSH287824J	3,252
28	84	24	C-CSH288424JL	C-CSH288424J	3,332
36	60	24	C-CSH366024JL	C-CSH366024J	3,246
36	66	24	C-CSH366624JL	C-CSH366624J	3,330
36	72	24	C-CSH367224JL	C-CSH367224J	3,419
36	78	24	C-CSH367824JL	C-CSH367824J	3,556
36	84	24	C-CSH368424JL	C-CSH368424J	3,645

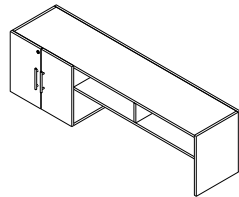

Cabinet Left

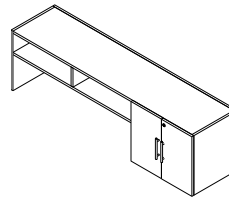

Cabinet Right

Specify

- Laminate Selection for Doors
- Laminate Selection for Case
- Choice of Handle

Notes

- Provides storage and space division facing one side only.
- Full finished back.
- 20" and 28" high unit has 8" high cubby above. 26" high unit has a 16" high cubby above.
- 60" - 72" wide units have 24" wide lockable storage cabinet with 1 adjustable shelf. 78" and 84" wide units have a 31 3/8" wide lockable storage cabinet with 1 adjustable shelf.
- Unit provided with rubber high friction strips for retention.

SPINE HUTCH A (18" DEEP)					SPINE HUTCH A (24" DEEP)				
H	W	D	Model Number	List	H	W	D	Model Number	List
12	24	18	C-CSH122418A	871	12	24	24	C-CSH122424A	953
12	30	18	C-CSH123018A	961	12	30	24	C-CSH123024A	1,031
12	36	18	C-CSH123618A	1,003	12	36	24	C-CSH123624A	1,083
12	42	18	C-CSH124218A	1,046	12	42	24	C-CSH124224A	1,136
12	48	18	C-CSH124818A	1,138	12	48	24	C-CSH124824A	1,238
12	54	18	C-CSH125418A	1,179	12	54	24	C-CSH125424A	1,290
12	60	18	C-CSH126018A	1,222	12	60	24	C-CSH126024A	1,342
12	66	18	C-CSH126618A	1,314	12	66	24	C-CSH126624A	1,444
12	72	18	C-CSH127218A	1,356	12	72	24	C-CSH127224A	1,497
16	24	18	C-CSH162418A	905	16	24	24	C-CSH162424A	972
16	30	18	C-CSH163018A	999	16	30	24	C-CSH163024A	1,077
16	36	18	C-CSH163618A	1,046	16	36	24	C-CSH163624A	1,133
16	42	18	C-CSH164218A	1,091	16	42	24	C-CSH164224A	1,189
16	48	18	C-CSH164818A	1,188	16	48	24	C-CSH164824A	1,294
16	54	18	C-CSH165418A	1,233	16	54	24	C-CSH165424A	1,350
16	60	18	C-CSH166018A	1,280	16	60	24	C-CSH166024A	1,406
16	66	18	C-CSH166618A	1,376	16	66	24	C-CSH166624A	1,513
16	72	18	C-CSH167218A	1,422	16	72	24	C-CSH167224A	1,569
20	24	18	C-CSH202418A	940	20	24	24	C-CSH202424A	1,014
20	30	18	C-CSH203018A	1,038	20	30	24	C-CSH203024A	1,121
20	36	18	C-CSH203618A	1,087	20	36	24	C-CSH203624A	1,180
20	42	18	C-CSH204218A	1,137	20	42	24	C-CSH204224A	1,240
20	48	18	C-CSH204818A	1,236	20	48	24	C-CSH204824A	1,350
20	54	18	C-CSH205418A	1,286	20	54	24	C-CSH205424A	1,409
20	60	18	C-CSH206018A	1,336	20	60	24	C-CSH206024A	1,469
20	66	18	C-CSH206618A	1,436	20	66	24	C-CSH206624A	1,579
20	72	18	C-CSH207218A	1,485	20	72	24	C-CSH207224A	1,638

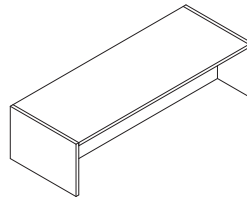

Specify

Notes

- Laminate Selection for Case
- Laminate Selection for Divider

- Provides storage and space division facing front and back.
- Unit provided with rubber high friction strips for retention.

Spine Hutch A

SPINE HUTCH A (18" DEEP)

H	W	D	Model Number	List
28	24	18	C-CSH282418A	1,014
28	30	18	C-CSH283018A	1,118
28	36	18	C-CSH283618A	1,176
28	42	18	C-CSH284218A	1,233
28	48	18	C-CSH284818A	1,340
28	54	18	C-CSH285418A	1,398
28	60	18	C-CSH286018A	1,455
28	66	18	C-CSH286618A	1,561
28	72	18	C-CSH287218A	1,619
36	24	18	C-CSH362418A	1,161
36	30	18	C-CSH363018A	1,280
36	36	18	C-CSH363618A	1,354
36	42	18	C-CSH364218A	1,426
36	48	18	C-CSH364818A	1,547
36	54	18	C-CSH365418A	1,621
36	60	18	C-CSH366018A	1,693
36	66	18	C-CSH366618A	1,812
36	72	18	C-CSH367218A	1,888

SPINE HUTCH A (24" DEEP)

H	W	D	Model Number	List
28	24	24	C-CSH282424A	1,101
28	30	24	C-CSH283024A	1,216
28	36	24	C-CSH283624A	1,283
28	42	24	C-CSH284224A	1,350
28	48	24	C-CSH284824A	1,467
28	54	24	C-CSH285424A	1,534
28	60	24	C-CSH286024A	1,601
28	66	24	C-CSH286624A	1,718
28	72	24	C-CSH287224A	1,785
36	24	24	C-CSH362424A	1,275
36	30	24	C-CSH363024A	1,404
36	36	24	C-CSH363624A	1,488
36	42	24	C-CSH364224A	1,570
36	48	24	C-CSH364824A	1,701
36	54	24	C-CSH365424A	1,785
36	60	24	C-CSH366024A	1,863
36	66	24	C-CSH366624A	1,995
36	72	24	C-CSH367224A	2,079

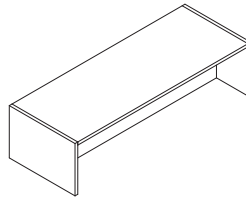

Specify

- Laminate Selection for Case
- Laminate Selection for Divider

Notes

- Provides storage and space division facing front and back.
- Unit provided with rubber high friction strips for retention.

SPINE HUTCH B (18" DEEP)						SPINE HUTCH B (24" DEEP)					
H	W	D	Open Left		List	H	W	D	Open Right		List
			Model Number	Model Number					Model Number	Model Number	
12	36	18	C-CSH123618BL	C-CSH123618BR	1,176	12	36	24	C-CSH123624BL	C-CSH123624BR	1,294
12	42	18	C-CSH124218BL	C-CSH124218BR	1,228	12	42	24	C-CSH124224BL	C-CSH124224BR	1,358
12	48	18	C-CSH124818BL	C-CSH124818BR	1,280	12	48	24	C-CSH124824BL	C-CSH124824BR	1,424
12	54	18	C-CSH125418BL	C-CSH125418BR	1,332	12	54	24	C-CSH125424BL	C-CSH125424BR	1,488
12	60	18	C-CSH126018BL	C-CSH126018BR	1,480	12	60	24	C-CSH126024BL	C-CSH126024BR	1,648
12	66	18	C-CSH126618BL	C-CSH126618BR	1,531	12	66	24	C-CSH126624BL	C-CSH126624BR	1,712
12	72	18	C-CSH127218BL	C-CSH127218BR	1,583	12	72	24	C-CSH127224BL	C-CSH127224BR	1,778
16	36	18	C-CSH163618BL	C-CSH163618BR	1,248	16	36	24	C-CSH163624BL	C-CSH163624BR	1,378
16	42	18	C-CSH164218BL	C-CSH164218BR	1,304	16	42	24	C-CSH164224BL	C-CSH164224BR	1,447
16	48	18	C-CSH164818BL	C-CSH164818BR	1,359	16	48	24	C-CSH164824BL	C-CSH164824BR	1,516
16	54	18	C-CSH165418BL	C-CSH165418BR	1,415	16	54	24	C-CSH165424BL	C-CSH165424BR	1,584
16	60	18	C-CSH166018BL	C-CSH166018BR	1,567	16	60	24	C-CSH166024BL	C-CSH166024BR	1,750
16	66	18	C-CSH166618BL	C-CSH166618BR	1,623	16	66	24	C-CSH166624BL	C-CSH166624BR	1,818
16	72	18	C-CSH167218BL	C-CSH167218BR	1,679	16	72	24	C-CSH167224BL	C-CSH167224BR	1,886
20	36	18	C-CSH203618BL	C-CSH203618BR	1,310	20	36	24	C-CSH203624BL	C-CSH203624BR	1,454
20	42	18	C-CSH204218BL	C-CSH204218BR	1,370	20	42	24	C-CSH204224BL	C-CSH204224BR	1,526
20	48	18	C-CSH204818BL	C-CSH204818BR	1,431	20	48	24	C-CSH204824BL	C-CSH204824BR	1,599
20	54	18	C-CSH205418BL	C-CSH205418BR	1,491	20	54	24	C-CSH205424BL	C-CSH205424BR	1,672
20	60	18	C-CSH206018BL	C-CSH206018BR	1,647	20	60	24	C-CSH206024BL	C-CSH206024BR	1,841
20	66	18	C-CSH206618BL	C-CSH206618BR	1,707	20	66	24	C-CSH206624BL	C-CSH206624BR	1,914
20	72	18	C-CSH207218BL	C-CSH207218BR	1,767	20	72	24	C-CSH207224BL	C-CSH207224BR	1,987

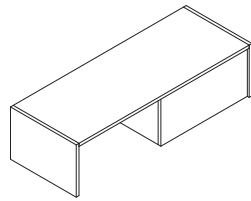

Open Left

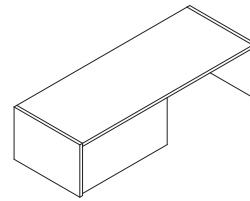

Open Right

Specify

- Laminate Selection for Case
- Laminate Selection for Divider

Notes

- Provides storage and space division facing front and back.
- Unit provided with rubber high friction strips for retention.
- Divider can be ordered as HPL Whiteboard. Divider is always same color on both sides.

Spine Hutch B

SPINE HUTCH B (18" DEEP)					
H	W	D	Open Left	Open Right	List
			Model Number	Model Number	
28	36	18	C-CSH283618BL	C-CSH283618BR	1,437
28	42	18	C-CSH284218BL	C-CSH284218BR	1,506
28	48	18	C-CSH284818BL	C-CSH284818BR	1,575
28	54	18	C-CSH285418BL	C-CSH285418BR	1,643
28	60	18	C-CSH286018BL	C-CSH286018BR	1,808
28	66	18	C-CSH286618BL	C-CSH286618BR	1,877
28	72	18	C-CSH287218BL	C-CSH287218BR	1,945
36	36	18	C-CSH363618BL	C-CSH363618BR	1,692
36	42	18	C-CSH364218BL	C-CSH364218BR	1,780
36	48	18	C-CSH364818BL	C-CSH364818BR	1,862
36	54	18	C-CSH365418BL	C-CSH365418BR	1,947
36	60	18	C-CSH366018BL	C-CSH366018BR	2,128
36	66	18	C-CSH366618BL	C-CSH366618BR	2,216
36	72	18	C-CSH367218BL	C-CSH367218BR	2,301

SPINE HUTCH B (24" DEEP)					
H	W	D	Open Left	Open Right	List
			Model Number	Model Number	
28	36	24	C-CSH283624BL	C-CSH283624BR	1,606
28	42	24	C-CSH284224BL	C-CSH284224BR	1,688
28	48	24	C-CSH284824BL	C-CSH284824BR	1,769
28	54	24	C-CSH285424BL	C-CSH285424BR	1,850
28	60	24	C-CSH286024BL	C-CSH286024BR	2,028
28	66	24	C-CSH286624BL	C-CSH286624BR	2,110
28	72	24	C-CSH287224BL	C-CSH287224BR	2,191
36	36	24	C-CSH363624BL	C-CSH363624BR	1,910
36	42	24	C-CSH364224BL	C-CSH364224BR	2,010
36	48	24	C-CSH364824BL	C-CSH364824BR	2,111
36	54	24	C-CSH365424BL	C-CSH365424BR	2,206
36	60	24	C-CSH366024BL	C-CSH366024BR	2,403
36	66	24	C-CSH366624BL	C-CSH366624BR	2,501
36	72	24	C-CSH367224BL	C-CSH367224BR	2,598

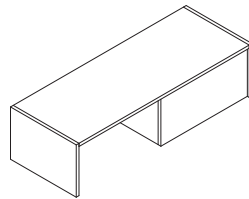

Left Hand

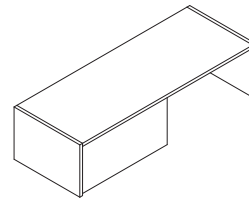

Right Hand

Specify

- Laminate Selection for Case
- Laminate Selection for Divider

Notes

- Provides storage and space division facing front and back.
- Unit provided with rubber high friction strips for retention.
- Divider can be ordered as HPL Whiteboard. Divider is always same color on both sides.

SPINE HUTCH C (24" DEEP)

H	W	D	Model Number	List
20	24	24	C-CSH202424C	1,508
20	30	24	C-CSH203024C	1,614
20	36	24	C-CSH203624C	1,760
20	42	24	C-CSH204224C	1,859
20	48	24	C-CSH204824C	1,971
20	54	24	C-CSH205424C	2,163
20	60	24	C-CSH206024C	2,261
20	66	24	C-CSH206624C	2,374
20	72	24	C-CSH207224C	2,565
20	78	24	C-CSH207824C	2,664
20	84	24	C-CSH208424C	2,763

SPINE HUTCH C (30" DEEP)

H	W	D	Model Number	List
20	24	30	C-CSH202430C	1,508
20	30	30	C-CSH203030C	1,614
20	36	30	C-CSH203630C	1,760
20	42	30	C-CSH204230C	1,859
20	48	30	C-CSH204830C	1,971
20	54	30	C-CSH205430C	2,163
20	60	30	C-CSH206030C	2,261
20	66	30	C-CSH206630C	2,374
20	72	30	C-CSH207230C	2,565
20	78	30	C-CSH207830C	2,664
20	84	30	C-CSH208430C	2,763

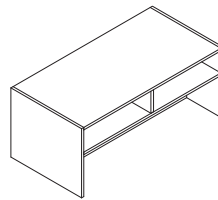

Specify

- Laminate Selection

Notes

- Provides storage and space division facing two sides.
- 20h unit has 8" high cubby above. 28" high has 8" or 16" high cubby above. 36" high has 16" high cubby.
- Unit provided with rubber high friction strips for retention.

Spine Hutch C

SPINE HUTCH C WITH 8" HIGH CUBBY SHELF (24" DEEP)

SPINE HUTCH C WITH 8" HIGH CUBBY SHELF (30" DEEP)

H	W	D	Cubby H	Model Number	List
28	24	24	8	C-CSH282424C8	1,662
28	30	24	8	C-CSH283024C8	1,777
28	36	24	8	C-CSH283624C8	1,915
28	42	24	8	C-CSH284224C8	1,991
28	48	24	8	C-CSH284824C8	2,112
28	54	24	8	C-CSH285424C8	2,312
28	60	24	8	C-CSH286024C8	2,419
28	66	24	8	C-CSH286624C8	2,539
28	72	24	8	C-CSH287224C8	2,739
28	78	24	8	C-CSH287824C8	2,847
28	84	24	8	C-CSH288424C8	2,954

H	W	D	Cubby H	Model Number	List
28	24	30	8	C-CSH282430C8	1,662
28	30	30	8	C-CSH283030C8	1,777
28	36	30	8	C-CSH283630C8	1,883
28	42	30	8	C-CSH284230C8	1,991
28	48	30	8	C-CSH284830C8	2,112
28	54	30	8	C-CSH285430C8	2,312
28	60	30	8	C-CSH286030C8	2,419
28	66	30	8	C-CSH286630C8	2,539
28	72	30	8	C-CSH287230C8	2,739
28	78	30	8	C-CSH287830C8	2,847
28	84	30	8	C-CSH288430C8	2,954

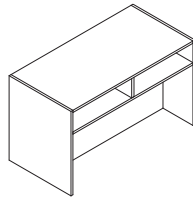

Specify

Notes

- Laminate Selection

- Provides storage and space division facing two sides.
- 20h unit has 8" high cubby above. 28" high has 8" or 16" high cubby above. 36" high has 16" high cubby.
- Unit provided with rubber high friction strips for retention.

SPINE HUTCH C WITH 16" HIGH CUBBY SHELF (24" DEEP)

SPINE HUTCH C WITH 16" HIGH CUBBY SHELF (30" DEEP)

H	W	D	Cubby H	Model Number	List
28	24	24	16	C-CSH282424C16	1,615
28	30	24	16	C-CSH283024C16	1,729
28	36	24	16	C-CSH283624C16	1,853
28	42	24	16	C-CSH284224C16	2,028
28	48	24	16	C-CSH284824C16	2,149
28	54	24	16	C-CSH285424C16	2,349
28	60	24	16	C-CSH286024C16	2,457
28	66	24	16	C-CSH286624C16	2,578
28	72	24	16	C-CSH287224C16	2,776
28	78	24	16	C-CSH287824C16	2,884
28	84	24	16	C-CSH288424C16	2,992
36	24	24	16	C-CSH362424C16	1,828
36	30	24	16	C-CSH363024C16	1,959
36	36	24	16	C-CSH363624C16	2,226
36	42	24	16	C-CSH364224C16	2,365
36	48	24	16	C-CSH364824C16	2,505
36	54	24	16	C-CSH365424C16	2,722
36	60	24	16	C-CSH366024C16	2,848
36	66	24	16	C-CSH366624C16	2,985
36	72	24	16	C-CSH367224C16	3,199
36	78	24	16	C-CSH367824C16	3,325
36	84	24	16	C-CSH368424C16	3,449

H	W	D	Cubby H	Model Number	List
28	24	30	16	C-CSH282430C16	1,615
28	30	30	16	C-CSH283030C16	1,729
28	36	30	16	C-CSH283630C16	1,920
28	42	30	16	C-CSH284230C16	2,028
28	48	30	16	C-CSH284830C16	2,149
28	54	30	16	C-CSH285430C16	2,349
28	60	30	16	C-CSH286030C16	2,457
28	66	30	16	C-CSH286630C16	2,578
28	72	30	16	C-CSH287230C16	2,776
28	78	30	16	C-CSH287830C16	2,884
28	84	30	16	C-CSH288430C16	2,992
36	24	30	16	C-CSH362430C16	1,921
36	30	30	16	C-CSH363030C16	2,054
36	36	30	16	C-CSH363630C16	2,167
36	42	30	16	C-CSH364230C16	2,291
36	48	30	16	C-CSH364830C16	2,431
36	54	30	16	C-CSH365430C16	2,647
36	60	30	16	C-CSH366030C16	2,773
36	66	30	16	C-CSH366630C16	2,909
36	72	30	16	C-CSH367230C16	3,124
36	78	30	16	C-CSH367830C16	3,250
36	84	30	16	C-CSH368430C16	3,375

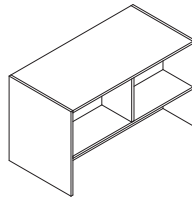

Specify

Notes

• Laminate Selection

- Provides storage and space division facing two sides.
- 20h unit has 8" high cubby above. 28" high has 8" or 16" high cubby above. 36" high has 16" high cubby.
- Unit provided with rubber high friction strips for retention.

Spine Hutch D

SPINE HUTCH D (18" DEEP)					
H	W	D	Open Left		List
			Model Number	Model Number	
20	36	18	C-CSH203618DL	C-CSH203618DR	1,587
20	42	18	C-CSH204218DL	C-CSH204218DR	1,667
20	48	18	C-CSH204818DL	C-CSH204818DR	1,725
20	54	18	C-CSH205418DL	C-CSH205418DR	1,922
20	60	18	C-CSH206018DL	C-CSH206018DR	2,006
20	66	18	C-CSH206618DL	C-CSH206618DR	2,090
20	72	18	C-CSH207218DL	C-CSH207218DR	2,262
20	78	18	C-CSH207818DL	C-CSH207818DR	2,342
20	84	18	C-CSH208418DL	C-CSH208418DR	2,430

SPINE HUTCH D WITH 8" HIGH CUBBY SHELF (18" DEEP)						
H	W	D	Shelf H	Open Left		List
				Model Number	Model Number	
28	36	18	8	C-CSH2836DL08	C-CSH2836DR08	1,693
28	42	18	8	C-CSH2842DL08	C-CSH2842DR08	1,782
28	48	18	8	C-CSH2848DL08	C-CSH2848DR08	1,874
28	54	18	8	C-CSH2854DL08	C-CSH2854DR08	2,054
28	60	18	8	C-CSH2860DL08	C-CSH2860DR08	2,146
28	66	18	8	C-CSH2866DL08	C-CSH2866DR08	2,239
28	72	18	8	C-CSH2872DL08	C-CSH2872DR08	2,419
28	78	18	8	C-CSH2878DL08	C-CSH2878DR08	2,508
28	84	18	8	C-CSH2884DL08	C-CSH2884DR08	2,604

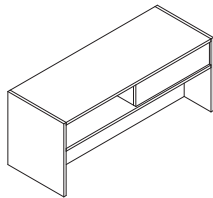

Open Left

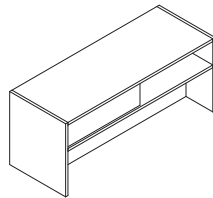

Open Right

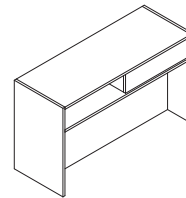

Open Left

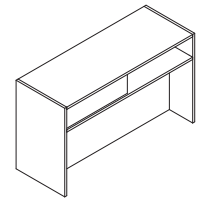

Open Right

Specify

- Laminate Selection for Case
- Laminate Selection for Divider

Notes

- Provides storage and space division facing two sides.
- 20" high unit has 8" high cubby above. 28" high has 8" or 16" high cubby above. 36" high has 16" high cubby.
- Unit provided with rubber high friction strips for retention.
- Top Yin-Yang Divider can be ordered as HPL Whiteboard. Divider is same color on both sides.

SPINE HUTCH D WITH 16" HIGH CUBBY SHELF

H	W	D	Shelf H	Open Left	Open Right	List
				Model Number	Model Number	
28	36	18	16	C-CSH2836DL16	C-CSH2836DR16	1,714
28	42	18	16	C-CSH2842DL16	C-CSH2842DR16	1,802
28	48	18	16	C-CSH2848DL16	C-CSH2848DR16	1,895
28	54	18	16	C-CSH2854DL16	C-CSH2854DR16	2,076
28	60	18	16	C-CSH2860DL16	C-CSH2860DR16	2,168
28	66	18	16	C-CSH2866DL16	C-CSH2866DR16	2,260
28	72	18	16	C-CSH2872DL16	C-CSH2872DR16	2,441
28	78	18	16	C-CSH2878DL16	C-CSH2878DR16	2,529
28	84	18	16	C-CSH2884DL16	C-CSH2884DR16	2,625
36	36	18	16	C-CSH3636DL16	C-CSH3636DR16	1,969
36	42	18	16	C-CSH3642DL16	C-CSH3642DR16	2,074
36	48	18	16	C-CSH3648DL16	C-CSH3648DR16	2,234
36	54	18	16	C-CSH3654DL16	C-CSH3654DR16	2,382
36	60	18	16	C-CSH3660DL16	C-CSH3660DR16	2,491
36	66	18	16	C-CSH3666DL16	C-CSH3666DR16	2,599
36	72	18	16	C-CSH3672DL16	C-CSH3672DR16	2,799
36	78	18	16	C-CSH3678DL16	C-CSH3678DR16	2,904
36	84	18	16	C-CSH3684DL16	C-CSH3684DR16	3,016

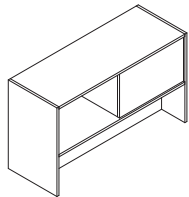

Open Left

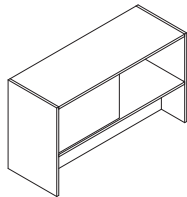

Open Right

Specify

- Laminate Selection for Case
- Laminate Selection for Divider

Notes

- Provides storage and space division facing two sides.
- 20" high unit has 8" high cubby above. 28" high has 8" or 16" high cubby above. 36" high has 16" high cubby.
- Unit provided with rubber high friction strips for retention.
- Top Yin-Yang Divider can be ordered as HPL Whiteboard. Divider is same color on both sides.

Spine Hutch E

SPINE HUTCH E (18" DEEP)					
H	W	D	Door Left	Door Right	List
			Model Number	Model Number	
28	36	18	C-CSH283618EL	C-CSH283618ER	2,182
28	42	18	C-CSH284218EL	C-CSH284218ER	2,285
28	48	18	C-CSH284818EL	C-CSH284818ER	2,391
28	54	18	C-CSH285418EL	C-CSH285418ER	2,591
28	60	18	C-CSH286018EL	C-CSH286018ER	2,701
28	66	18	C-CSH286618EL	C-CSH286618ER	2,807
28	72	18	C-CSH287218EL	C-CSH287218ER	2,910
28	78	18	C-CSH287818EL	C-CSH287818ER	3,012
28	84	18	C-CSH288418EL	C-CSH288418ER	3,130
36	36	18	C-CSH363618EL	C-CSH363618ER	2,437
36	42	18	C-CSH364218EL	C-CSH364218ER	2,556
36	48	18	C-CSH364818EL	C-CSH364818ER	2,731
36	54	18	C-CSH365418EL	C-CSH365418ER	2,897
36	60	18	C-CSH366018EL	C-CSH366018ER	3,024
36	66	18	C-CSH366618EL	C-CSH366618ER	3,147
36	72	18	C-CSH367218EL	C-CSH367218ER	3,268
36	78	18	C-CSH367818EL	C-CSH367818ER	3,387
36	84	18	C-CSH368418EL	C-CSH368418ER	3,522

SPINE HUTCH E (24" DEEP)					
H	W	D	Door Left	Door Right	List
			Model Number	Model Number	
28	36	24	C-CSH283624EL	C-CSH283624ER	2,345
28	42	24	C-CSH284224EL	C-CSH284224ER	2,462
28	48	24	C-CSH284824EL	C-CSH284824ER	2,584
28	54	24	C-CSH285424EL	C-CSH285424ER	2,798
28	60	24	C-CSH286024EL	C-CSH286024ER	2,923
28	66	24	C-CSH286624EL	C-CSH286624ER	3,044
28	72	24	C-CSH287224EL	C-CSH287224ER	3,161
28	78	24	C-CSH287824EL	C-CSH287824ER	3,279
28	84	24	C-CSH288424EL	C-CSH288424ER	3,412
36	36	24	C-CSH363624EL	C-CSH363624ER	2,599
36	42	24	C-CSH364224EL	C-CSH364224ER	2,733
36	48	24	C-CSH364824EL	C-CSH364824ER	2,923
36	54	24	C-CSH365424EL	C-CSH365424ER	3,104
36	60	24	C-CSH366024EL	C-CSH366024ER	3,246
36	66	24	C-CSH366624EL	C-CSH366624ER	3,384
36	72	24	C-CSH367224EL	C-CSH367224ER	3,519
36	78	24	C-CSH367824EL	C-CSH367824ER	3,654
36	84	24	C-CSH368424EL	C-CSH368424ER	3,803

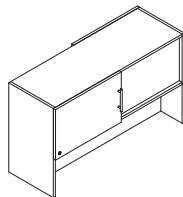

Door Left

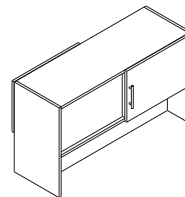

Door Right

Specify

- Laminate Selection for Case
- Laminate Selection for Divider
- Laminate Selection for Door
- Choice of Handle

Notes

- Provides storage and space division facing two sides with lockable sliding door.
- Unit provided with rubber high friction strips for retention.
- Top Yin-Yang Divider can be ordered as HPL Whiteboard. Divider is same color on both sides.

SPINE HUTCH H (18" DEEP)						
H	W	D	Cantilevered		Full Panel	
			Model Number	List	Model Number	List
20	60	18	C-CSH206018H	2,457	C-CSH206018HF	2,537
20	66	18	C-CSH206618H	2,509	C-CSH206618HF	2,590
20	72	18	C-CSH207218H	2,565	C-CSH207218HF	2,642
20	78	18	C-CSH207818H	2,643	C-CSH207818HF	2,711
20	84	18	C-CSH208418H	2,702	C-CSH208418HF	2,763
28	60	18	C-CSH286018H	2,660	C-CSH286018HF	2,771
28	66	18	C-CSH286618H	2,720	C-CSH286618HF	2,831
28	72	18	C-CSH287218H	2,784	C-CSH287218HF	2,891
28	78	18	C-CSH287818H	2,879	C-CSH287818HF	2,977
28	84	18	C-CSH288418H	2,945	C-CSH288418HF	3,037
36	60	18	C-CSH366018H	2,864	C-CSH366018HF	3,005
36	66	18	C-CSH366618H	2,932	C-CSH366618HF	3,072
36	72	18	C-CSH367218H	3,002	C-CSH367218HF	3,141
36	78	18	C-CSH367818H	3,115	C-CSH367818HF	3,243
36	84	18	C-CSH368418H	3,188	C-CSH368418HF	3,311

SPINE HUTCH H (24" DEEP)						
H	W	D	Cantilevered		Full Panel	
			Model Number	List	Model Number	List
20	60	24	C-CSH206024H	2,646	C-CSH206024HF	2,727
20	66	24	C-CSH206624H	2,709	C-CSH206624HF	2,790
20	72	24	C-CSH207224H	2,776	C-CSH207224HF	2,854
20	78	24	C-CSH207824H	2,866	C-CSH207824HF	2,934
20	84	24	C-CSH208424H	2,936	C-CSH208424HF	2,997
28	60	24	C-CSH286024H	2,873	C-CSH286024HF	2,983
28	66	24	C-CSH286624H	2,943	C-CSH286624HF	3,055
28	72	24	C-CSH287224H	3,019	C-CSH287224HF	3,125
28	78	24	C-CSH287824H	3,124	C-CSH287824HF	3,222
28	84	24	C-CSH288424H	3,202	C-CSH288424HF	3,293
36	60	24	C-CSH366024H	3,099	C-CSH366024HF	3,240
36	66	24	C-CSH366624H	3,177	C-CSH366624HF	3,320
36	72	24	C-CSH367224H	3,261	C-CSH367224HF	3,396
36	78	24	C-CSH367824H	3,382	C-CSH367824HF	3,511
36	84	24	C-CSH368424H	3,468	C-CSH368424HF	3,589

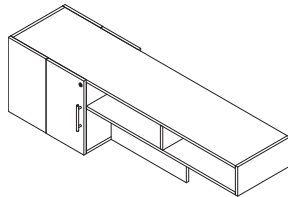

Cantilevered

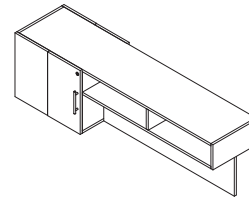

Full Panel

Specify

- Laminate Selection for Case
- Laminate Selection for Door
- Choice of Handle

Notes

- Provides storage and space division facing two sides.
- 20" and 28" high unit has 8" high cubby above. 36" high unit has a 16" high cubby above.
- 60" - 72" wide units have (2) 12" wide lockable storage cabinets arranged in Yin-Yang configuration. 78" and 84" wide units have (2) 15 5/8" wide lockable storage cabinets arranged in Yin-Yang configuration.
- Doors on both sides are hinge left to open towards overhead/cantilevered side of hutch.
- Hutch can be ordered with a full width lower panel or with a cantilevered section that leaves 24 1/4" space (on all widths) for collaboration.
- Unit provided with rubber high friction strips for retention.
- **Important:** Maximum shelf weight 20 lbs per front and back.

Spine Hutch K

SPINE HUTCH K (18" DEEP)

H	W	D	Model Number	List
28	36	18	C-CSH283618K	1,541
28	42	18	C-CSH284218K	1,600
28	48	18	C-CSH284818K	1,659
28	54	18	C-CSH285418K	2,016
28	60	18	C-CSH286018K	2,075
28	66	18	C-CSH286618K	2,139
28	72	18	C-CSH287218K	2,296
28	78	18	C-CSH287818K	2,355
28	84	18	C-CSH288418K	2,414
36	36	18	C-CSH373618K	1,634
36	42	18	C-CSH374218K	1,697
36	48	18	C-CSH374818K	1,760
36	54	18	C-CSH375418K	2,168
36	60	18	C-CSH376018K	2,231
36	66	18	C-CSH376618K	2,299
36	72	18	C-CSH377218K	2,461
36	78	18	C-CSH377818K	2,524
36	84	18	C-CSH378418K	2,586

SPINE HUTCH K (24" DEEP)

H	W	D	Model Number	List
28	36	24	C-CSH283624K	1,701
28	42	24	C-CSH284224K	1,776
28	48	24	C-CSH284824K	1,850
28	54	24	C-CSH285424K	2,268
28	60	24	C-CSH286024K	2,342
28	66	24	C-CSH286624K	2,422
28	72	24	C-CSH287224K	2,594
28	78	24	C-CSH287824K	2,669
28	84	24	C-CSH288424K	2,743
36	36	24	C-CSH373624K	1,818
36	42	24	C-CSH374224K	1,897
36	48	24	C-CSH374824K	1,974
36	54	24	C-CSH375424K	2,459
36	60	24	C-CSH376024K	2,536
36	66	24	C-CSH376624K	2,620
36	72	24	C-CSH377224K	2,797
36	78	24	C-CSH377824K	2,875
36	84	24	C-CSH378424K	2,953

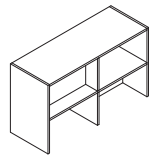

28" High

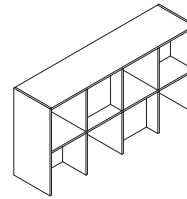

36" High

Specify

- Laminate Selection for Case
- Laminate Selection for Divider

Notes

- Provides storage and space division facing two sides.
- Shelves are arranged in Yin-Yang configuration alternating 4" and 12" deep and open.

SPINE CABINET L (18" DEEP)					
H	W	D	Door Left		List
			Model Number	Model Number	
20	24	18	C-CSC202418LL	C-CSC202418LR	1,545
20	30	18	C-CSC203018LL	C-CSC203018LR	1,644
20	36	18	C-CSC203618LL	C-CSC203618LR	1,797
20	42	18	C-CSC204218LL	C-CSC204218LR	1,897
20	48	18	C-CSC204818LL	C-CSC204818LR	1,996
28	24	18	C-CSC282418LL	C-CSC282418LR	1,740
28	30	18	C-CSC283018LL	C-CSC283018LR	1,857
28	36	18	C-CSC283618LL	C-CSC283618LR	2,027
28	42	18	C-CSC284218LL	C-CSC284218LR	2,143
28	48	18	C-CSC284818LL	C-CSC284818LR	2,260
36	24	18	C-CSC362418LL	C-CSC362418LR	1,936
36	30	18	C-CSC363018LL	C-CSC363018LR	2,070
36	36	18	C-CSC363618LL	C-CSC363618LR	2,257
36	42	18	C-CSC364218LL	C-CSC364218LR	2,389
36	48	18	C-CSC364818LL	C-CSC364818LR	2,524

SPINE CABINET L (24" DEEP)					
H	W	D	Door Left		List
			Model Number	Model Number	
20	24	24	C-CSC202424LL	C-CSC202424LR	1,684
20	30	24	C-CSC203024LL	C-CSC203024LR	1,802
20	36	24	C-CSC203624LL	C-CSC203624LR	1,975
20	42	24	C-CSC204224LL	C-CSC204224LR	2,093
20	48	24	C-CSC204824LL	C-CSC204824LR	2,211
28	24	24	C-CSC282424LL	C-CSC282424LR	1,906
28	30	24	C-CSC283024LL	C-CSC283024LR	2,042
28	36	24	C-CSC283624LL	C-CSC283624LR	2,230
28	42	24	C-CSC284224LL	C-CSC284224LR	2,365
28	48	24	C-CSC284824LL	C-CSC284824LR	2,501
36	24	24	C-CSC362424LL	C-CSC362424LR	2,127
36	30	24	C-CSC363024LL	C-CSC363024LR	2,281
36	36	24	C-CSC363624LL	C-CSC363624LR	2,484
36	42	24	C-CSC364224LL	C-CSC364224LR	2,638
36	48	24	C-CSC364824LL	C-CSC364824LR	2,791

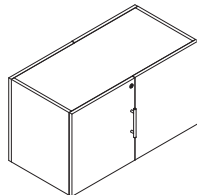

Door Left

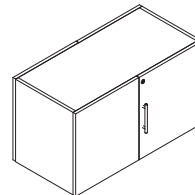

Door Right

Specify

- Laminate Selection for Case
- Laminate Selection for Door and Panel
- Choice of Handle

Notes

- Provides storage and space division facing two sides with lockable cabinet doors arranged in yin-yang configuration.
- "Door Left" Units have Left Hinge Doors. "Door Right" Units have Right Hinge Doors.
- Unit provided with rubber high friction strips for retention.
- Doors and panels can be ordered as HPL Whiteboard.

Spine Cabinet M

SPINE CABINET M (18" DEEP)					
H	W	D	Door Left	Door Right	List
			Model Number	Model Number	
16	36	18	C-CSC163618ML	C-CSC163618MR	1,944
16	42	18	C-CSC164218ML	C-CSC164218MR	2,015
16	48	18	C-CSC164818ML	C-CSC164818MR	2,085
16	54	18	C-CSC165418ML	C-CSC165418MR	2,346
16	60	18	C-CSC166018ML	C-CSC166018MR	2,423
16	66	18	C-CSC166618ML	C-CSC166618MR	2,495
16	72	18	C-CSC167218ML	C-CSC167218MR	2,565
16	78	18	C-CSC167818ML	C-CSC167818MR	2,636
16	84	18	C-CSC168418ML	C-CSC168418MR	2,722
20	36	18	C-CSC203618ML	C-CSC203618MR	2,086
20	42	18	C-CSC204218ML	C-CSC204218MR	2,165
20	48	18	C-CSC204818ML	C-CSC204818MR	2,244
20	54	18	C-CSC205418ML	C-CSC205418MR	2,536
20	60	18	C-CSC206018ML	C-CSC206018MR	2,623
20	66	18	C-CSC206618ML	C-CSC206618MR	2,702
20	72	18	C-CSC207218ML	C-CSC207218MR	2,781
20	78	18	C-CSC207818ML	C-CSC207818MR	2,859
20	84	18	C-CSC208418ML	C-CSC208418MR	2,953

SPINE CABINET M (24" DEEP)					
H	W	D	Door Left	Door Right	List
			Model Number	Model Number	
16	36	24	C-CSC163624ML	C-CSC163624MR	2,070
16	42	24	C-CSC164224ML	C-CSC164224MR	2,153
16	48	24	C-CSC164824ML	C-CSC164824MR	2,237
16	54	24	C-CSC165424ML	C-CSC165424MR	2,549
16	60	24	C-CSC166024ML	C-CSC166024MR	2,640
16	66	24	C-CSC166624ML	C-CSC166624MR	2,724
16	72	24	C-CSC167224ML	C-CSC167224MR	2,806
16	78	24	C-CSC167824ML	C-CSC167824MR	2,890
16	84	24	C-CSC168424ML	C-CSC168424MR	2,989
20	36	24	C-CSC203624ML	C-CSC203624MR	2,225
20	42	24	C-CSC204224ML	C-CSC204224MR	2,317
20	48	24	C-CSC204824ML	C-CSC204824MR	2,408
20	54	24	C-CSC205424ML	C-CSC205424MR	2,761
20	60	24	C-CSC206024ML	C-CSC206024MR	2,860
20	66	24	C-CSC206624ML	C-CSC206624MR	2,951
20	72	24	C-CSC207224ML	C-CSC207224MR	3,043
20	78	24	C-CSC207824ML	C-CSC207824MR	3,136
20	84	24	C-CSC208424ML	C-CSC208424MR	3,242

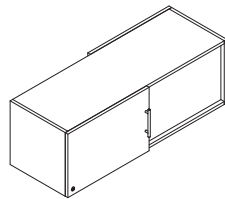

Door Left

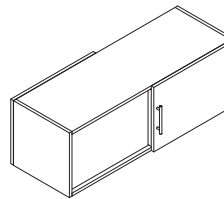

Door Right

Specify

- Laminate Selection for Case
- Laminate Selection for Divider
- Laminate Selection for Door
- Choice of Handle

Notes

- Provides storage and space division facing two sides with lockable sliding door.
- Unit provided with rubber high friction strips for retention.
- Yin-Yang Divider can be ordered as HPL Whiteboard. Divider is same color on both sides.

SPINE CABINET M (18" DEEP)					
H	W	D	Door Left	Door Right	List
			Model Number	Model Number	
28	36	18	C-CSC283618ML	C-CSC283618MR	2,341
28	42	18	C-CSC284218ML	C-CSC284218MR	2,436
28	48	18	C-CSC284818ML	C-CSC284818MR	2,584
28	54	18	C-CSC285418ML	C-CSC285418MR	2,843
28	60	18	C-CSC286018ML	C-CSC286018MR	2,946
28	66	18	C-CSC286618ML	C-CSC286618MR	3,041
28	72	18	C-CSC287218ML	C-CSC287218MR	3,139
28	78	18	C-CSC287818ML	C-CSC287818MR	3,234
28	84	18	C-CSC288418ML	C-CSC288418MR	3,345
36	36	18	C-CSC363618ML	C-CSC363618MR	2,595
36	42	18	C-CSC364218ML	C-CSC364218MR	2,707
36	48	18	C-CSC364818ML	C-CSC364818MR	2,923
36	54	18	C-CSC365418ML	C-CSC365418MR	3,149
36	60	18	C-CSC366018ML	C-CSC366018MR	3,269
36	66	18	C-CSC366618ML	C-CSC366618MR	3,381
36	72	18	C-CSC367218ML	C-CSC367218MR	3,497
36	78	18	C-CSC367818ML	C-CSC367818MR	3,609
36	84	18	C-CSC368418ML	C-CSC368418MR	3,736

SPINE CABINET M (24" DEEP)					
H	W	D	Door Left	Door Right	List
			Model Number	Model Number	
28	36	24	C-CSC283624ML	C-CSC283624MR	2,479
28	42	24	C-CSC284224ML	C-CSC284224MR	2,588
28	48	24	C-CSC284824ML	C-CSC284824MR	2,747
28	54	24	C-CSC285424ML	C-CSC285424MR	3,067
28	60	24	C-CSC286024ML	C-CSC286024MR	3,183
28	66	24	C-CSC286624ML	C-CSC286624MR	3,291
28	72	24	C-CSC287224ML	C-CSC287224MR	3,402
28	78	24	C-CSC287824ML	C-CSC287824MR	3,510
28	84	24	C-CSC288424ML	C-CSC288424MR	3,633
36	36	24	C-CSC363624ML	C-CSC363624MR	2,734
36	42	24	C-CSC364224ML	C-CSC364224MR	2,859
36	48	24	C-CSC364824ML	C-CSC364824MR	3,087
36	54	24	C-CSC365424ML	C-CSC365424MR	3,374
36	60	24	C-CSC366024ML	C-CSC366024MR	3,506
36	66	24	C-CSC366624ML	C-CSC366624MR	3,630
36	72	24	C-CSC367224ML	C-CSC367224MR	3,760
36	78	24	C-CSC367824ML	C-CSC367824MR	3,885
36	84	24	C-CSC368424ML	C-CSC368424MR	4,025

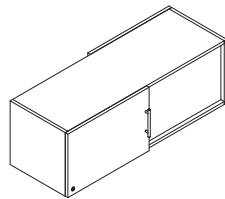

Door Left

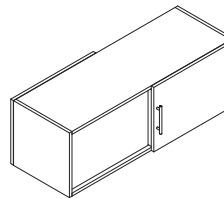

Door Right

Specify

- Laminate Selection for Case
- Laminate Selection for Divider
- Laminate Selection for Door
- Choice of Handle

Notes

- Provides storage and space division facing two sides with lockable sliding door.
- Unit provided with rubber high friction strips for retention.
- Yin-Yang Divider can be ordered as HPL Whiteboard. Divider is same color on both sides.

13" High Floor Storage

13" HIGH STORAGE WITH SINGLE BOTTOM BOX DRAWER

H	W	D	Model Number	List
13	15	18	C-CLATF1815	1,178
13	18	18	C-CLATF1818	1,264
13	24	18	C-CLATF1824	1,351
13	30	18	C-CLATF1830	1,438
13	36	18	C-CLATF1836	1,525
13	42	18	C-CLATF1842	1,611
13	15	24	C-CLATF2415	1,267
13	18	24	C-CLATF2418	1,366
13	24	24	C-CLATF2424	1,464
13	30	24	C-CLATF2430	1,562
13	36	24	C-CLATF2436	1,661
13	42	24	C-CLATF2442	1,757

13" HIGH STORAGE WITH BOTTOM AND HIDDEN TOP BOX DRAWER

H	W	D	Model Number	List
13	15	18	C-CLATB1815	1,295
13	18	18	C-CLATB1818	1,391
13	24	18	C-CLATB1824	1,487
13	30	18	C-CLATB1830	1,582
13	36	18	C-CLATB1836	1,677
13	42	18	C-CLATB1842	1,772
13	15	24	C-CLATB2415	1,394
13	18	24	C-CLATB2418	1,502
13	24	24	C-CLATB2424	1,610
13	30	24	C-CLATB2430	1,719
13	36	24	C-CLATB2436	1,826
13	42	24	C-CLATB2442	1,932

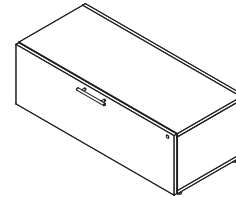
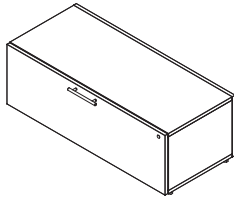

Specify

Notes

- | | |
|---|---|
| <ul style="list-style-type: none"> • Laminate Selection for Case • Laminate Selection for Face/Drawer • Choice of Handle | <ul style="list-style-type: none"> • 13" high storage can be used to support 21" high spines. • Single low bottom box drawer or with hidden top drawer as well. • Cannot accommodate filing. |
|---|---|

21" High BF Pedestals

BF PEDESTALS

H	W	D	Depth	Counterweight	Model Number	List
21	12	18	Full	Y	X-BFPFS182112	1,405
21	12	23	Partial	N	X-BFPFS232112	1,437
21	12	24	Full	Y	X-BFPFS242112	1,505
21	16	18	Full	Y	X-BFP18	1,560
21	16	23	Partial	N	X-BFP22C	1,598
21	16	24	Full	Y	X-BFP24	1,671
21	18	18	Full	Y	X-BFPFS182118	1,659
21	18	23	Partial	N	X-BFPFS232118	1,697
21	18	24	Full	Y	X-BFPFS242118	1,776
21	24	18	Full	Y	X-BFPFS182124	1,824
21	24	23	Partial	N	X-BFPFS232124	1,867
21	24	24	Full	Y	X-BFPFS242124	1,954

BF PEDESTALS ON FEET

H	W	D	Depth	Counterweight	Model Number	List
21	12	18	Full	Y	C-BFPFS182112	1,456
21	12	23	Partial	N	C-BFPFS232112	1,488
21	12	24	Full	Y	C-BFPFS242112	1,554
21	16	18	Full	Y	C-BFP18	1,616
21	16	23	Partial	N	C-BFP22	1,652
21	16	24	Full	Y	C-BFP24	1,727
21	18	18	Full	Y	C-BFPFS182118	1,718
21	18	23	Partial	N	C-BFPFS232118	1,757
21	18	24	Full	Y	C-BFPFS242118	1,836
21	24	18	Full	Y	C-BFPFS182124	1,889
21	24	23	Partial	N	C-BFPFS232124	1,932
21	24	24	Full	Y	C-BFPFS242124	2,019

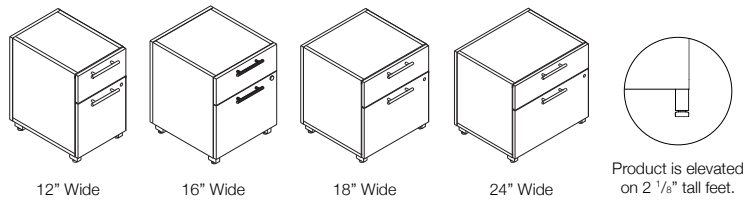
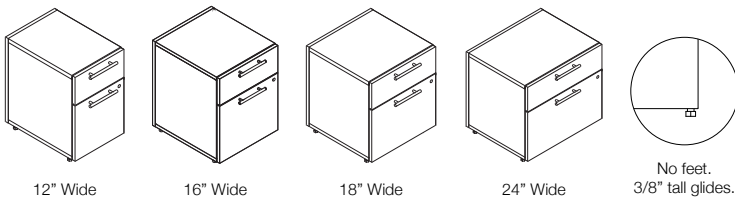

Specify

Notes

- Laminate Selection for Case
- Laminate Selection for Face/Drawer
- Choice of Handle

- 21" high storage can be used to support 29" high spines.

21" High Hidden Drawer BF Pedestals

HIDDEN DRAWER BF PEDESTALS

H	W	D	Depth	Counterweight	Model Number	List
21	12	18	Full	Y	X-BFPH211218	1,412
21	12	23	Partial	N	X-BFPH211223	1,443
21	12	24	Full	Y	X-BFPH211224	1,507
21	16	18	Full	Y	X-BFPH211618	1,567
21	16	23	Partial	N	X-BFPH211623	1,603
21	16	24	Full	Y	X-BFPH211624	1,675
21	18	18	Full	Y	X-BFPH211818	1,609
21	18	23	Partial	N	X-BFPH211823	1,646
21	18	24	Full	Y	X-BFPH211824	1,723

HIDDEN DRAWER BF PEDESTALS ON FEET

H	W	D	Depth	Counterweight	Model Number	List
21	12	18	Full	Y	C-BFPHD211218	1,364
21	12	23	Partial	N	C-BFPHD211223	1,394
21	12	24	Full	Y	C-BFPHD211224	1,457
21	16	18	Full	Y	C-BFPHD211618	1,514
21	16	23	Partial	N	C-BFPHD211623	1,550
21	16	24	Full	Y	C-BFPHD211624	1,621
21	18	18	Full	Y	C-BFPHD211818	1,666
21	18	23	Partial	N	C-BFPHD211823	1,704
21	18	24	Full	Y	C-BFPHD211824	1,781

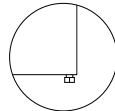
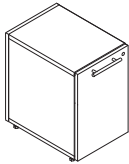

No feet.
3/8" tall glides.

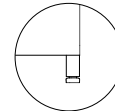
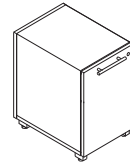

Product is elevated
on 2 1/8" tall feet.

Specify

- Laminate Selection for Case
- Laminate Selection for Face/Drawer
- Handle Selection

Notes

- 21" high storage can be used to support 29" high spines.

21" High Lateral Floor Storage

BF LATERALS

H	W	D	Depth	Counterweight	Model Number	List
21	30	18	Full	Y	X-PLAT2D3018	2,050
21	36	18	Full	Y	X-PLAT2D3618	2,163
21	42	18	Full	Y	X-PLAT2D4218	2,276
21	30	22	Partial*	N	X-PLAT2D3022C	2,136
21	36	22	Partial*	N	X-PLAT2D3622C	2,256
21	42	22	Partial*	N	X-PLAT2D4222C	2,376
21	30	24	Full	Y	X-PLAT2D3024	2,204
21	36	24	Full	Y	X-PLAT2D3624	2,332
21	42	24	Full	Y	X-PLAT2D4224	2,459

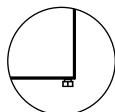
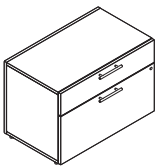

No feet.
3/8" tall glides.

BF LATERALS ON FEET

H	W	D	Depth	Counterweight	Model Number	List
21	30	18	Full	Y	C-PLATJ2D30	2,105
21	36	18	Full	Y	C-PLATJ2D36	2,219
21	42	18	Full	Y	C-PLATJ2D42	2,332
21	30	22	Partial*	N	C-PLAT2D3022	2,191
21	36	22	Partial*	N	C-PLAT2D3622	2,311
21	42	22	Partial*	N	C-PLAT2D4222	2,431
21	30	24	Full	Y	C-PLAT2D3024	2,260
21	36	24	Full	Y	C-PLAT2D3624	2,387
21	42	24	Full	Y	C-PLAT2D4224	2,515

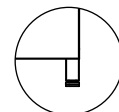
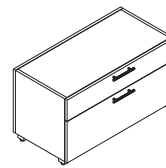

Product is elevated
on 2 1/8" tall feet.

Specify

- Laminate Selection for Case
- Laminate Selection for Face/Drawer
- Choice of Handle

Notes

- 21" high storage can be used to support 29" high spines.

21" High Floor Bookcases

FLOOR BOOKCASES				
H	W	D	Model Number	List
21	24	14	X-BC202414	1,096
21	30	14	X-BC203014	1,140
21	36	14	X-BC203614	1,321
21	42	14	X-BC204214	1,360
21	48	14	X-BC204814	1,406
21	54	14	X-BC205414	1,679
21	60	14	X-BC206014	1,724
21	66	14	X-BC206614	1,766
21	72	14	X-BC207214	1,806
21	24	18	X-CBC2024	1,113
21	30	18	X-CBC2030	1,167
21	36	18	X-CBC2036	1,367
21	42	18	X-CBC2042	1,415
21	48	18	X-CBC2048	1,468
21	54	18	X-CBC2054	1,723
21	60	18	X-CBC2060	1,772
21	66	18	X-CBC2066	1,826
21	72	18	X-CBC2072	1,876
21	24	24	X-CBC202424	1,113
21	30	24	X-CBC203024	1,152
21	36	24	X-CBC203624	1,365
21	42	24	X-CBC204224	1,419
21	48	24	X-CBC204824	1,468
21	54	24	X-CBC205424	1,705
21	60	24	X-CBC206024	1,760
21	66	24	X-CBC206624	1,822
21	72	24	X-CBC207224	1,879

FLOOR BOOKCASES ON FEET				
H	W	D	Model Number	List
21	24	14	C-BC202414	1,151
21	30	14	C-BC203014	1,196
21	36	14	C-BC203614	1,376
21	42	14	C-BC204214	1,416
21	48	14	C-BC204814	1,462
21	54	14	C-BC205414	1,735
21	60	14	C-BC206014	1,779
21	66	14	C-BC206614	1,822
21	72	14	C-BC207214	1,861
21	24	18	C-BC202418	1,169
21	30	18	C-BC203018	1,222
21	36	18	C-BC203618	1,422
21	42	18	C-BC204218	1,471
21	48	18	C-BC204818	1,524
21	54	18	C-BC205418	1,778
21	60	18	C-BC206018	1,828
21	66	18	C-BC206618	1,882
21	72	18	C-BC207218	1,932
21	24	24	C-BC202424	1,145
21	30	24	C-BC203024	1,206
21	36	24	C-BC203624	1,416
21	42	24	C-BC204224	1,473
21	48	24	C-BC204824	1,532
21	54	24	C-BC205424	1,757
21	60	24	C-BC206024	1,815
21	66	24	C-BC206624	1,876
21	72	24	C-BC207224	1,933

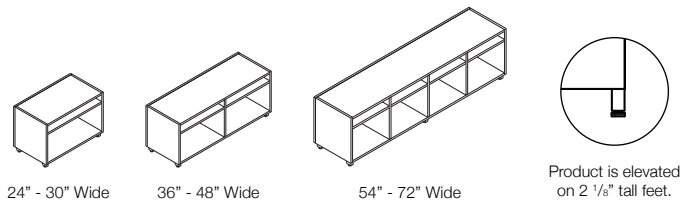
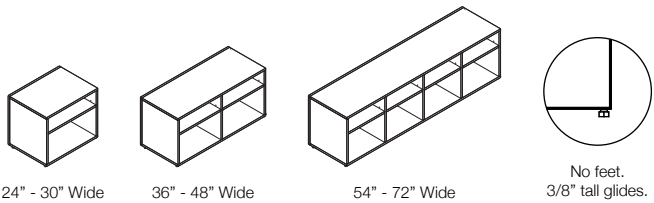

Specify

Notes

• Laminate Selection for Unit

• 21" high storage can be used to support 29" high spines.

21" High Shared Floor Bookcases

SHARED FLOOR BOOKCASES

H	W	D	Open Left	Open Right	List
			Model Number	Model Number	
21	36	18	X-CBCSL213618	X-CBCSR213618	1,381
21	42	18	X-CBCSL214218	X-CBCSR214218	1,430
21	48	18	X-CBCSL214818	X-CBCSR214818	1,478
21	54	18	X-CBCSL215418	X-CBCSR215418	1,734
21	60	18	X-CBCSL216018	X-CBCSR216018	1,789
21	66	18	X-CBCSL216618	X-CBCSR216618	1,839
21	72	18	X-CBCSL217218	X-CBCSR217218	1,887

SHARED FLOOR BOOKCASES ON FEET

H	W	D	Open Left	Open Right	List
			Model Number	Model Number	
21	36	18	C-YFBCL2036	C-YFBCR2036	1,436
21	42	18	C-YFBCL2042	C-YFBCR2042	1,486
21	48	18	C-YFBCL2048	C-YFBCR2048	1,534
21	54	18	C-CBCSL215418	C-CBCSR215418	1,790
21	60	18	C-YFBCL2060	C-YFBCR2060	1,845
21	66	18	C-YFBCL2066	C-YFBCR2066	1,894
21	72	18	C-YFBCL2072	C-YFBCR2072	1,943

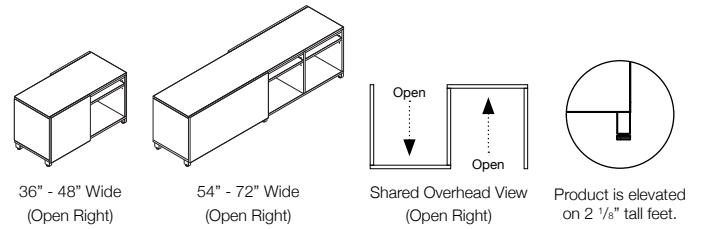
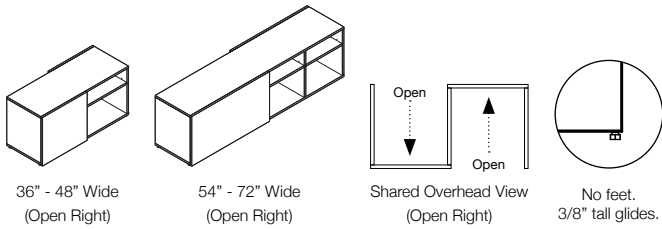

Specify

- Laminate Selection for Case
- Laminate Selection for Face

Notes

- 21" high storage can be used to support 29" high spines.

21" High Floor Cabinets

TWO DOOR CABINETS

H	W	D	Model Number	List
21	24	18	X-CCD2024	1,436
21	30	18	X-CCD2030	1,500
21	36	18	X-CCD2036	1,615
21	42	18	X-CCD2042	1,676
21	48	18	X-CCD2048	1,742

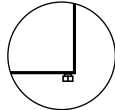
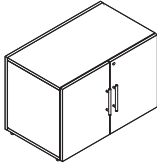

No feet.
3/8" tall glides.

TWO DOOR CABINETS ON FEET

H	W	D	Model Number	List
21	24	18	C-CC202418L	1,492
21	30	18	C-CC203018L	1,556
21	36	18	C-CC203618L	1,671
21	42	18	C-CC204218L	1,732
21	48	18	C-CC204818L	1,798

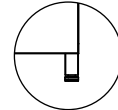
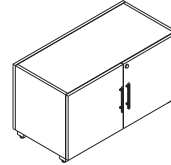

Product is elevated
on 2 1/8" tall feet.

FOUR DOOR CABINETS

H	W	D	Model Number	List
21	54	18	X-CCD2054	2,124
21	60	18	X-CCD2060	2,188
21	66	18	X-CCD2066	2,252
21	72	18	X-CCD2072	2,315

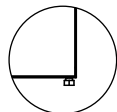
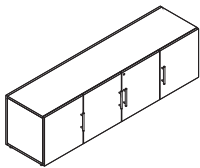

No feet.
3/8" tall glides.

FOUR DOOR CABINETS ON FEET

H	W	D	Model Number	List
21	54	18	C-CC205418L	2,180
21	60	18	C-CC206018L	2,244
21	66	18	C-CC206618L	2,308
21	72	18	C-CC207218L	2,370

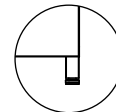
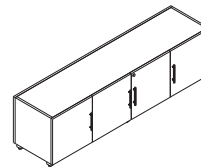

Product is elevated
on 2 1/8" tall feet.

Specify

- Laminate Selection for Case
- Laminate Selection for Door/Face
- Choice of Handle

Notes

- 21" high storage can be used to support 29" high spines.
- On four door cabinets only the center doors are lockable.

21" High Floor Credenzas

CREDENZAS WITH SLIDING DOORS

H	W	D	Left-Side Lock	Right-Side Lock	List
			Model Number	Model Number	
21	30	18	X-CSDL2030	X-CSDR2030	1,606
21	36	18	X-CSDL2036	X-CSDR2036	1,649
21	42	18	X-CSDL2042	X-CSDR2042	1,694
21	48	18	X-CSDL2048	X-CSDR2048	1,741
21	54	18	X-CSDL2054	X-CSDR2054	1,979
21	60	18	X-CSDL2060	X-CSDR2060	2,028
21	66	18	X-CSDL2066	X-CSDR2066	2,073
21	72	18	X-CSDL2072	X-CSDR2072	2,117

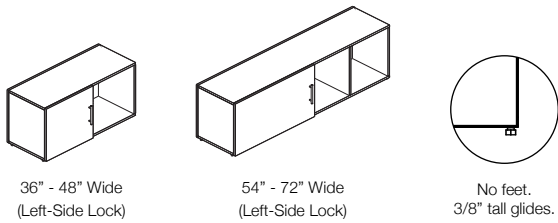

CREDENZAS WITH SLIDING DOORS ON FEET

H	W	D	Left-Side Lock	Right-Side Lock	List
			Model Number	Model Number	
21	30	18	C-CS203018LL	C-CS203018RL	1,606
21	36	18	C-CS203618LL	C-CS203618RL	1,649
21	42	18	C-CS204218LL	C-CS204218RL	1,694
21	48	18	C-CS204818LL	C-CS204818RL	1,741
21	54	18	C-CS205418LL	C-CS205418RL	1,979
21	60	18	C-CS206018LL	C-CS206018RL	2,028
21	66	18	C-CS206618LL	C-CS206618RL	2,073
21	72	18	C-CS207218LL	C-CS207218RL	2,117

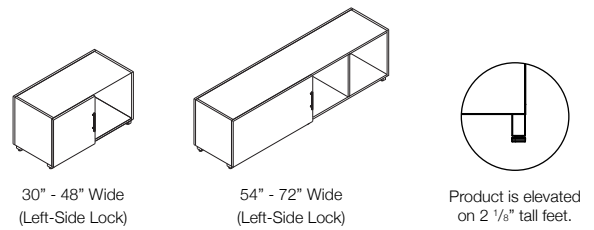

SHARED CREDENZAS WITH SLIDING DOORS

H	W	D	Left-Side Lock	Right-Side Lock	List
			Model Number	Model Number	
21	36	18	X-CBCSDSL211836	X-CBCSDSR211836	2,225
21	42	18	X-CBCSDSL211842	X-CBCSDSR211842	2,288
21	48	18	X-CBCSDSL211848	X-CBCSDSR211848	2,348
21	54	18	X-CBCSDSL211854	X-CBCSDSR211854	2,489
21	60	18	X-CBCSDSL211860	X-CBCSDSR211860	2,563
21	66	18	X-CBCSDSL211866	X-CBCSDSR211866	2,621
21	72	18	X-CBCSDSL211872	X-CBCSDSR211872	2,680

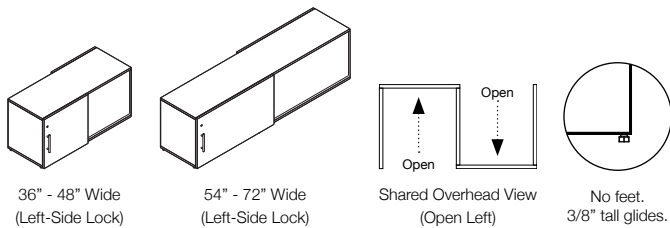

SHARED CREDENZAS WITH SLIDING DOORS ON FEET

H	W	D	Left-Side Lock	Right-Side Lock	List
			Model Number	Model Number	
21	36	18	C-YFBCSDL2036	C-YFBCSDR2036	2,280
21	42	18	C-YFBCSDL2042	C-YFBCSDR2042	2,344
21	48	18	C-YFBCSDL2048	C-YFBCSDR2048	2,404
21	54	18	C-CBCSDSL211854	C-CBCSDSR211854	2,545
21	60	18	C-YFBCSDL2060	C-YFBCSDR2060	2,619
21	66	18	C-YFBCSDL2066	C-YFBCSDR2066	2,677
21	72	18	C-YFBCSDL2072	C-YFBCSDR2072	2,736

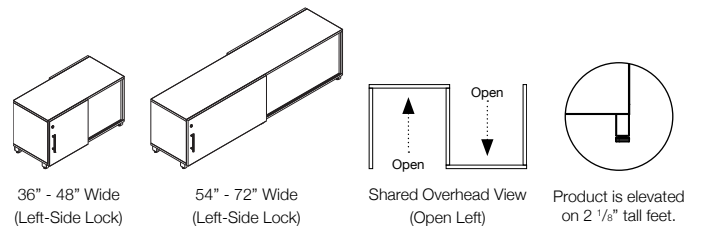

Specify

- Laminate Selection for Case
- Laminate Selection for Doors/Face
- Choice of Handle

Notes

- 21" high storage can be used to support 29" high spines.

21" High Combo Units with BF Pedestal and Bookcase

COMBO UNITS WITH BF PEDESTAL AND BOOKCASE

H	W	D	Bookcase Left	Bookcase Right	List
			Model Number	Model Number	
21	30	18	X-BFCBCR213018	X-BFCBCL213018	1,790
21	36	18	X-BFCBCR213618	X-BFCBCL213618	1,897
21	42	18	X-BFCBCR214218	X-BFCBCL214218	2,005
21	48	18	X-BFCBCR214818	X-BFCBCL214818	2,059
21	54	18	X-BFCBCR215418	X-BFCBCL215418	2,495
21	60	18	X-BFCBCR216018	X-BFCBCL216018	2,548
21	66	18	X-BFCBCR216618	X-BFCBCL216618	2,747
21	72	18	X-BFCBCR217218	X-BFCBCL217218	2,797
21	30	24	X-BFCBCR213024	X-BFCBCL213024	1,916
21	36	24	X-BFCBCR213624	X-BFCBCL213624	2,025
21	42	24	X-BFCBCR214224	X-BFCBCL214224	2,132
21	48	24	X-BFCBCR214824	X-BFCBCL214824	2,191
21	54	24	X-BFCBCR215424	X-BFCBCL215424	2,666
21	60	24	X-BFCBCR216024	X-BFCBCL216024	2,724
21	66	24	X-BFCBCR216624	X-BFCBCL216624	2,924
21	72	24	X-BFCBCR217224	X-BFCBCL217224	2,974

COMBO UNITS WITH BF PEDESTAL AND BOOKCASE ON FEET

H	W	D	Bookcase Left	Bookcase Right	List
			Model Number	Model Number	
21	30	18	C-BFCBCR213018	C-BFCBCL213018	1,902
21	36	18	C-BFCBCR213618	C-BFCBCL213618	2,008
21	42	18	C-BFCBCR214218	C-BFCBCL214218	2,117
21	48	18	C-BFCBCR214818	C-BFCBCL214818	2,225
21	54	18	C-BFCBCR215418	C-BFCBCL215418	2,606
21	60	18	C-BFCBCR216018	C-BFCBCL216018	2,658
21	66	18	C-BFCBCR216618	C-BFCBCL216618	2,859
21	72	18	C-BFCBCR217218	C-BFCBCL217218	2,908
21	30	24	C-BFCBCR213024	C-BFCBCL213024	1,972
21	36	24	C-BFCBCR213624	C-BFCBCL213624	2,080
21	42	24	C-BFCBCR214224	C-BFCBCL214224	2,187
21	48	24	C-BFCBCR214824	C-BFCBCL214824	2,302
21	54	24	C-BFCBCR215424	C-BFCBCL215424	2,776
21	60	24	C-BFCBCR216024	C-BFCBCL216024	2,835
21	66	24	C-BFCBCR216624	C-BFCBCL216624	3,036
21	72	24	C-BFCBCR217224	C-BFCBCL217224	3,085

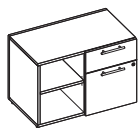

36" - 48" Wide
(Bookcase Left)

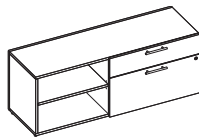

54" - 72" Wide
(Bookcase Left)

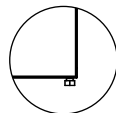

No feet.
3/8" tall glides.



36" - 48" Wide
(Bookcase Left)

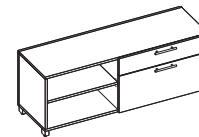

54" - 72" Wide
(Bookcase Left)

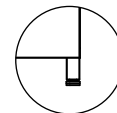

Product is elevated
on 2 1/8" tall feet.

Specify

- Laminate Selection for Case
- Laminate Selection for Drawers/Face
- Choice of Handle

Notes

- On sizes 36" - 48" wide, pedestal width is 15.78 wide. On sizes 54" - 72" wide, drawer width is 30" wide.
- 21" high storage can be used to support 29" high spines.

Electrical Jumpers

ELECTRICAL JUMPERS

Actual L	Model Number	List
18	E-MX8W4PTPC18	168
21	E-MX8W4PTPC21	176
24	E-UN8W4VT16	214
30	E-UN8W4J30	219
33	E-HM8W4PJ24	220
37	E-MW8W4PJ18	220
39	E-HM8W4PJ30	220
43	E-MW8W4PJ24	240
45	E-MW8W4PJ24E	250
48	E-UN8W4J48	219
49	E-MW8W4PJ30	258
51	E-MW8W4PJ30E	262
55	E-MW8W4PJ36	265
57	E-MW8W4PJ36E	271
61	E-MW8W4PJ42	274
63	E-MW8W4PJ42E	279
67	E-MW8W4PJ48	295
69	E-MW8W4PJ48E	303
79	E-MW8W4PJ60	317
81	E-MW8W4PJ60E	334
86	E-MW8W4PJ86	364

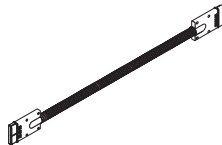

Calibrate Community Jumper Specification Grid:
Jumper length when joining powered spine beams together.

Spine Width	To 36"	To 42"	To 48"	To 54"	To 60"	To 66"	To 72"	To 78"	To 84"	To 90"	To 96"
From 36"	24	30	33	33	37	37	43	43	48	51	55
From 42"	30	30	33	37	39	43	43	48	51	55	57
From 48"	33	33	37	39	43	43	48	51	55	57	61
From 54"	33	37	39	43	43	48	51	55	57	61	63
From 60"	37	39	43	43	48	51	55	57	61	63	67
From 66"	37	43	43	48	51	55	57	61	63	67	69
From 72"	43	43	48	51	55	57	61	63	67	69	79
From 78"	43	48	51	55	57	61	63	67	69	79	79
From 84"	48	51	55	57	61	63	67	69	69	79	79
from 90"	51	55	57	61	63	67	69	79	79	79	79
From 96"	55	57	61	63	67	69	79	79	79	79	86

Notes

- Electrical jumpers connect powered spines.
- Electrical jumpers are listed in actual lengths to assist with specification. Jumper use is explained in the chart on this page.
- Single and Double Sided Spines require connecting on one side of spine only.
- **Important:** Certain areas of Chicago prohibit the use of modular electrical systems and require all electrical components to be hard wired. All electrical components need to be supplied by the electrician.

Outlets

DUPLEX OUTLETS

Line	Model Number	List
1	E-MW8W4DO1	60
2	E-MW8W4DO2	60
3	E-MW8W4DO3	60
4	E-MW8W4DO4	60

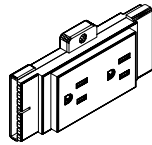

Notes

- Black duplex outlets, designated circuits 1 through 4, contain two single receptacles (places to plug into) of the same circuit and are specified separately.
- Outlets are screw-mounted to powerway.
- Duplex outlets are standard 15amp outlets.
- 2+2 Power with Line 5 outlets available upon request. 20amp outlets available upon request.

CALIFORNIA TITLE 24 CONTROLLED DUPLEX OUTLETS

Line	Model Number	List
1	E-MW8W4T24DO1	70
2	E-MW8W4T24DO2	70
3	E-MW8W4T24DO3	70
4	E-MW8W4T24DO4	70

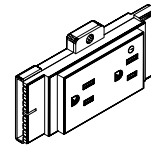

"Controlled" Symbol

Notes

- In California, 50 percent of all outlets in a systems panel cluster or benching cluster, for new construction, MUST be controlled outlets, even if there is no task lighting.
- Customers should plan on using circuits 2 and 3 for controlled circuits, and plan general load for all other items on circuits 1 and 4.
- If using 2 + 2 configuration, controlled circuits should be 1 and 2, and general load circuits on 4 and 5.
- Outlets must have the "controlled" symbol for identification purposes.

USB OUTLETS

Line	Model Number	List
1	E-UN8W4USB01	252
2	E-UN8W4USB02	252
3	E-UN8W4USB03	252
4	E-UN8W4USB04	252

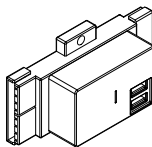

Notes

- USB Outlets bring USB charging options to panel power distribution systems.
- Provide convenient charging power access through dual ports on the face of the receptacle.
- Offer a total of 2 Amps between two USB charging ports.
- UL and FCC Part 15A approved.
- Unit protrudes 1" past faceplate.

DUPLEX OUTLET COVER

Model Number	List
E-UNWC	23

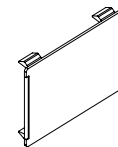

Specify

- Color Selection for Cover

Notes

- Duplex outlet covers are ordered only when extra covers are required.
- One cover is included with every surface kit.

DATA PLATE KIT

Item	Model Number	List
6 Port Data Gang Plate	E-HDP6B-SM	27
CAT 5e Jack	E-HRJ45-SM	97
CAT 6 Data Jack	E-HXJ6BK-SM	106
Hole Blank (10 Pack)	E-SFBB10-SM	65

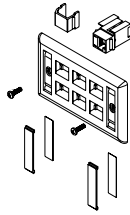

Notes

- Single Data Plate Kit has six ports for modular jacks.
- Bezel screws directly to the access box in pre-drilled and tapped hole pattern.
- RJ-45 jacks can be used in place of RJ-11 jacks.

SINGLE GANG PLATE ADAPTER

Model Number	List
E-DJA	36

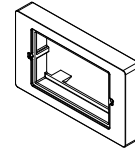

Notes

- Single Gang Plate Adapter (1) provided with each access box to adapt single gang plates to box.
- Single gang plates cannot be used with “grommet only” option.

Infeeds for Infeed Base Supports

SIDE-MOUNTED BASE INFEEDS

Actual L	Use	Model Number	List
72"	Standard	E-UN8W4BIFS	385
72"	New York City	E-HM8W4BIFSNY	767

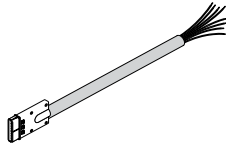

Notes

- Side-mounted base infeeds provide interface with building power at the end of the power units and mounts to the powerway at jumper location.
- Each base infeed is 6' in length, encased in "liquid tight".
- New York City code requires the use of a special base feed with an in-line junction box.

CEILING INFEED

Actual L	Model Number	List
144"	E-UN8W4CIF	459

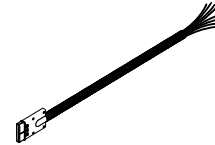

Notes

- Ceiling infeeds provide interface with building power from a suspended ceiling through a power pole shell.
- Each ceiling feed is 12' long.
- Power pole shells are ordered separately.

END MOUNT POLE

Type	Model Number	List	Grade C Paint
For 21 High	T-BEMP21	1,122	+25
For 29 High	T-BEMP29	1,122	+25



Specify

Notes

- Paint Selection
- End mount poles are used for concealing ceiling infeeds or data cables from a max 11'6" standard suspended ceiling.
- Choose pole that corresponds to the spine height.
- Order ceiling feed separately.
- Poles must be attached to ceiling grids at time of installation and will not support pole alone.
- Poles require cutting standard round 2 3/4" grommet in end panels.

Tackboards for Spine Hutch A

PET TACKBOARD FOR SPINE HUTCH A

H	W	Model Number	List
12	24	C-CTACK1224A	290
12	30	C-CTACK1230A	306
12	36	C-CTACK1236A	320
12	42	C-CTACK1242A	351
12	48	C-CTACK1248A	366
12	54	C-CTACK1254A	381
12	60	C-CTACK1260A	397
12	66	C-CTACK1266A	412
12	72	C-CTACK1272A	427
16	24	C-CTACK1624A	306
16	30	C-CTACK1630A	336
16	36	C-CTACK1636A	351
16	42	C-CTACK1642A	366
16	48	C-CTACK1648A	381
16	54	C-CTACK1654A	412
16	60	C-CTACK1660A	427
16	66	C-CTACK1666A	442
16	72	C-CTACK1672A	458
20	24	C-CTACK2024A	320
20	30	C-CTACK2030A	351
20	36	C-CTACK2036A	366
20	42	C-CTACK2042A	397
20	48	C-CTACK2048A	412
20	54	C-CTACK2054A	427
20	60	C-CTACK2060A	458
20	66	C-CTACK2066A	472
20	72	C-CTACK2072A	504

FABRIC TACKBOARD FOR SPINE HUTCH A

H	W	Model Number	List	Fabric Grade C	Fabric Grade D
12	24	C-CTACKF1224A	572	+11	+23
12	30	C-CTACKF1230A	579	+11	+23
12	36	C-CTACKF1236A	585	+11	+23
12	42	C-CTACKF1242A	592	+11	+23
12	48	C-CTACKF1248A	607	+11	+23
12	54	C-CTACKF1254A	623	+11	+23
12	60	C-CTACKF1260A	639	+11	+23
12	66	C-CTACKF1266A	627	+11	+23
12	72	C-CTACKF1272A	640	+11	+23
16	24	C-CTACKF1624A	588	+17	+37
16	30	C-CTACKF1630A	596	+17	+37
16	36	C-CTACKF1636A	604	+17	+37
16	42	C-CTACKF1642A	612	+17	+37
16	48	C-CTACKF1648A	626	+17	+37
16	54	C-CTACKF1654A	640	+17	+37
16	60	C-CTACKF1660A	654	+17	+37
16	66	C-CTACKF1666A	676	+17	+37
16	72	C-CTACKF1672A	692	+17	+37
20	24	C-CTACKF2024A	604	+23	+50
20	30	C-CTACKF2030A	613	+23	+50
20	36	C-CTACKF2036A	623	+23	+50
20	42	C-CTACKF2042A	632	+23	+50
20	48	C-CTACKF2048A	647	+23	+50
20	54	C-CTACKF2054A	664	+23	+50
20	60	C-CTACKF2060A	679	+23	+50
20	66	C-CTACKF2066A	696	+23	+50
20	72	C-CTACKF2072A	714	+23	+50

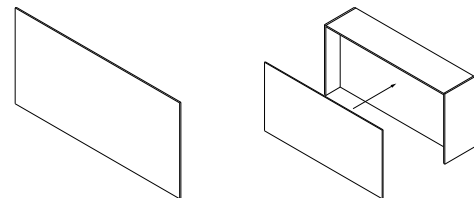
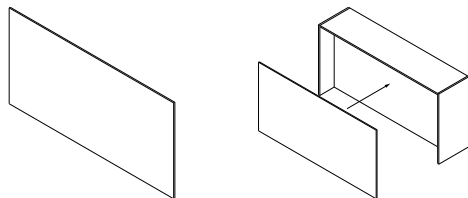

Specify

- Color Selection for PET- Lite Grey, Medium Grey, Tan or Vibrant Blue

Notes

- Match each tackboard to its specific hutch using height, width and style dimensions.
- On PET tackboards, tack holes may remain visible after tacks have been removed.

Specify

- Fabric Selection

Notes

- Match each tackboard to its specific hutch using height, width and style dimensions.
- Tackboard fabric direction is vertical on 24" to 48" wide units and will run horizontally for 54" to 96" wide pieces.

Tackboards for Spine Hutch A

PET TACKBOARD FOR SPINE HUTCH A

H	W	Model Number	List
28	24	C-CTACK2824A	351
28	30	C-CTACK2830A	381
28	36	C-CTACK2836A	412
28	42	C-CTACK2842A	442
28	48	C-CTACK2848A	458
28	54	C-CTACK2854A	488
28	60	C-CTACK2860A	518
28	66	C-CTACK2866A	549
28	72	C-CTACK2872A	565
36	24	C-CTACK3624A	381
36	30	C-CTACK3630A	427
36	36	C-CTACK3636A	458
36	42	C-CTACK3642A	488
36	48	C-CTACK3648A	518
36	54	C-CTACK3654A	549
36	60	C-CTACK3660A	579
36	66	C-CTACK3666A	610
36	72	C-CTACK3672A	640

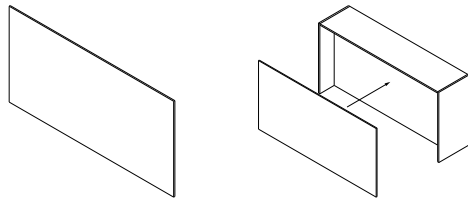

Specify **Notes**

- Color Selection for PET- Lite Grey, Medium Grey, Tan or Vibrant Blue
- Match each tackboard to it's specific hutch using height, width and style dimensions.
- On PET tackboards, tack holes may remain visible after tacks have been removed.

FABRIC TACKBOARD FOR SPINE HUTCH A

H	W	Model Number	List	Fabric Grade C	Fabric Grade D
28	24	C-CTACKF2824A	637	+34	+73
28	30	C-CTACKF2830A	648	+34	+73
28	36	C-CTACKF2836A	660	+34	+73
28	42	C-CTACKF2842A	671	+34	+73
28	48	C-CTACKF2848A	685	+34	+73
28	54	C-CTACKF2854A	697	+34	+73
28	60	C-CTACKF2860A	709	+34	+73
28	66	C-CTACKF2866A	793	+34	+73
28	72	C-CTACKF2872A	818	+34	+73
36	24	C-CTACKF3624A	668	+46	+100
36	30	C-CTACKF3630A	683	+46	+100
36	36	C-CTACKF3636A	697	+46	+100
36	42	C-CTACKF3642A	712	+46	+100
36	48	C-CTACKF3648A	728	+46	+100
36	54	C-CTACKF3654A	746	+46	+100
36	60	C-CTACKF3660A	760	+46	+100
36	66	C-CTACKF3666A	834	+46	+100
36	72	C-CTACKF3672A	861	+46	+100

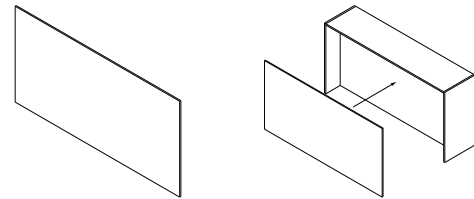

Specify **Notes**

- Fabric Selection
- Match each tackboard to it's specific hutch using height, width and style dimensions.
- Tackboard fabric direction is vertical on 24" to 48" wide units and will run horizontally for 54" to 96" wide pieces.

Tackboards for Spine Hutch B

PET TACKBOARD FOR SPINE HUTCH B

H	W	Model Number	List
12	36	C-CTACK1236B	320
12	42	C-CTACK1242B	351
12	48	C-CTACK1248B	366
12	54	C-CTACK1254B	381
12	60	C-CTACK1260B	397
12	66	C-CTACK1266B	412
12	72	C-CTACK1272B	427
16	36	C-CTACK1636B	351
16	42	C-CTACK1642B	366
16	48	C-CTACK1648B	381
16	54	C-CTACK1654B	412
16	60	C-CTACK1660B	427
16	66	C-CTACK1666B	442
16	72	C-CTACK1672B	458
20	36	C-CTACK2036B	366
20	42	C-CTACK2042B	397
20	48	C-CTACK2048B	412
20	54	C-CTACK2054B	427
20	60	C-CTACK2060B	458
20	66	C-CTACK2066B	472
20	72	C-CTACK2072B	504

FABRIC TACKBOARD FOR SPINE HUTCH B

H	W	Model Number	List	Fabric Grade C	Fabric Grade D
12	36	C-CTACKF1236B	585	+11	+23
12	42	C-CTACKF1242B	592	+11	+23
12	48	C-CTACKF1248B	607	+11	+23
12	54	C-CTACKF1254B	623	+11	+23
12	60	C-CTACKF1260B	639	+11	+23
12	66	C-CTACKF1266B	627	+11	+23
12	72	C-CTACKF1272B	640	+11	+23
16	36	C-CTACKF1636B	604	+17	+37
16	42	C-CTACKF1642B	612	+17	+37
16	48	C-CTACKF1648B	626	+17	+37
16	54	C-CTACKF1654B	640	+17	+37
16	60	C-CTACKF1660B	654	+17	+37
16	66	C-CTACKF1666B	676	+17	+37
16	72	C-CTACKF1672B	692	+17	+37
20	36	C-CTACKF2036B	623	+23	+50
20	42	C-CTACKF2042B	632	+23	+50
20	48	C-CTACKF2048B	647	+23	+50
20	54	C-CTACKF2054B	664	+23	+50
20	60	C-CTACKF2060B	679	+23	+50
20	66	C-CTACKF2066B	696	+23	+50
20	72	C-CTACKF2072B	714	+23	+50

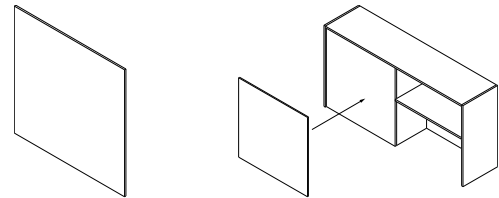
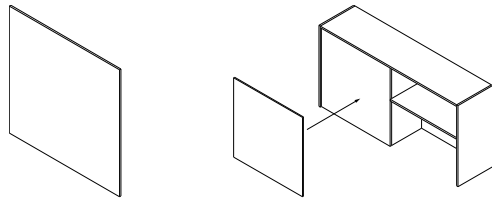

Specify **Notes**

- Color Selection for PET- Lite Grey, Medium Grey, Tan or Vibrant Blue
- Match each tackboard to it's specific hutch using height, width and style dimensions.
- On PET tackboards, tack holes may remain visible after tacks have been removed.

Specify **Notes**

- Fabric Selection
- Match each tackboard to it's specific hutch using height, width and style dimensions.
- Tackboard fabric direction is vertical on 24" to 48" wide units and will run horizontally for 54" to 96" wide pieces.

Tackboards for Spine Hutch B

PET TACKBOARD FOR SPINE HUTCH B

H	W	Model Number	List
28	36	C-CTACK2836B	412
28	42	C-CTACK2842B	442
28	48	C-CTACK2848B	458
28	54	C-CTACK2854B	488
28	60	C-CTACK2860B	518
28	66	C-CTACK2866B	549
28	72	C-CTACK2872B	565
36	36	C-CTACK3636B	458
36	42	C-CTACK3642B	488
36	48	C-CTACK3648B	518
36	54	C-CTACK3654B	549
36	60	C-CTACK3660B	579
36	66	C-CTACK3666B	610
36	72	C-CTACK3672B	640

FABRIC TACKBOARD FOR SPINE HUTCH B

H	W	Model Number	List	Fabric Grade C	Fabric Grade D
28	36	C-CTACKF2836B	660	+34	+73
28	42	C-CTACKF2842B	671	+34	+73
28	48	C-CTACKF2848B	685	+34	+73
28	54	C-CTACKF2854B	697	+34	+73
28	60	C-CTACKF2860B	709	+34	+73
28	66	C-CTACKF2866B	793	+34	+73
28	72	C-CTACKF2872B	818	+34	+73
36	36	C-CTACKF3636B	697	+46	+100
36	42	C-CTACKF3642B	712	+46	+100
36	48	C-CTACKF3648B	728	+46	+100
36	54	C-CTACKF3654B	746	+46	+100
36	60	C-CTACKF3660B	760	+46	+100
36	66	C-CTACKF3666B	834	+46	+100
36	72	C-CTACKF3672B	861	+46	+100

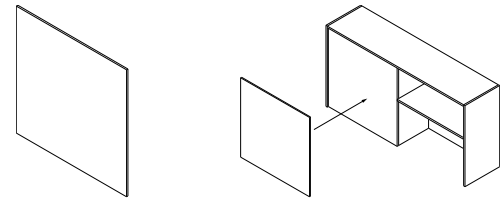
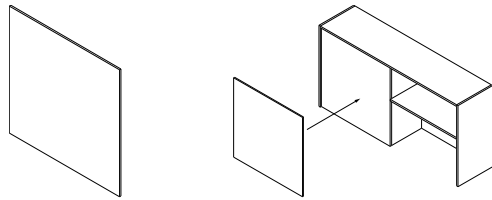

Specify **Notes**

- Color Selection for PET-Lite Grey, Medium Grey, Tan or Vibrant Blue
- Match each tackboard to it's specific hutch using height, width and style dimensions.
- On PET tackboards, tack holes may remain visible after tacks have been removed.

Specify **Notes**

- Fabric Selection
- Match each tackboard to it's specific hutch using height, width and style dimensions.
- Tackboard fabric direction is vertical on 24" to 48" wide units and will run horizontally for 54" to 96" wide pieces.

Tackboards for Spine Hutch C

PET TACKBOARD FOR SPINE HUTCH C

H	W	Model Number	List
20	24	C-CTACK2024C	320
20	30	C-CTACK2030C	351
20	36	C-CTACK2036C	366
20	42	C-CTACK2042C	397
20	48	C-CTACK2048C	412
20	54	C-CTACK2054C	427
20	60	C-CTACK2060C	458
20	66	C-CTACK2066C	472
20	72	C-CTACK2072C	504
20	78	C-CTACK2078C	518
20	84	C-CTACK2084C	534
28	24	C-CTACK2824C	351
28	30	C-CTACK2830C	381
28	36	C-CTACK2836C	412
28	42	C-CTACK2842C	442
28	48	C-CTACK2848C	458
28	54	C-CTACK2854C	488
28	60	C-CTACK2860C	518
28	66	C-CTACK2866C	549
28	72	C-CTACK2872C	565
28	78	C-CTACK2878C	595
28	84	C-CTACK2884C	625
36	24	C-CTACK3624C	381
36	30	C-CTACK3630C	427
36	36	C-CTACK3636C	458
36	42	C-CTACK3642C	488
36	48	C-CTACK3648C	518
36	54	C-CTACK3654C	549
36	60	C-CTACK3660C	579
36	66	C-CTACK3666C	610
36	72	C-CTACK3672C	640
36	78	C-CTACK3678C	671
36	84	C-CTACK3684C	701

FABRIC TACKBOARD FOR SPINE HUTCH C

H	W	Model Number	List	Fabric Grade C	Fabric Grade D
20	24	C-CTACKF2024C	604	+11	+23
20	30	C-CTACKF2030C	613	+11	+23
20	36	C-CTACKF2036C	623	+11	+23
20	42	C-CTACKF2042C	632	+11	+23
20	48	C-CTACKF2048C	647	+11	+23
20	54	C-CTACKF2054C	664	+11	+23
20	60	C-CTACKF2060C	679	+11	+23
20	66	C-CTACKF2066C	696	+11	+23
20	72	C-CTACKF2072C	714	+11	+23
20	78	C-CTACKF2078C	731	+11	+23
20	84	C-CTACKF2084C	749	+11	+23
28	24	C-CTACKF2824C	637	+17	+37
28	30	C-CTACKF2830C	648	+17	+37
28	36	C-CTACKF2836C	660	+17	+37
28	42	C-CTACKF2842C	671	+17	+37
28	48	C-CTACKF2848C	685	+17	+37
28	54	C-CTACKF2854C	697	+17	+37
28	60	C-CTACKF2860C	709	+17	+37
28	66	C-CTACKF2866C	793	+17	+37
28	72	C-CTACKF2872C	818	+17	+37
28	78	C-CTACKF2878C	843	+17	+37
28	84	C-CTACKF2884C	868	+17	+37
36	24	C-CTACKF3624C	668	+23	+50
36	30	C-CTACKF3630C	683	+23	+50
36	36	C-CTACKF3636C	697	+23	+50
36	42	C-CTACKF3642C	712	+23	+50
36	48	C-CTACKF3648C	728	+23	+50
36	54	C-CTACKF3654C	746	+23	+50
36	60	C-CTACKF3660C	760	+23	+50
36	66	C-CTACKF3666C	834	+23	+50
36	72	C-CTACKF3672C	861	+23	+50
36	78	C-CTACKF3678C	887	+23	+50
36	84	C-CTACKF3684C	914	+23	+50

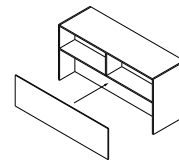
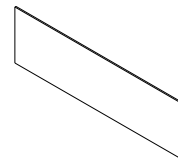
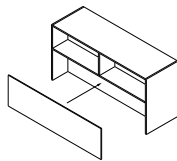
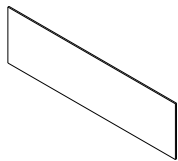

Specify

Notes

- Color Selection for PET- Lite Grey, Medium Grey, Tan or Vibrant Blue

- Match each tackboard to it's specific hutch using height, width and style dimensions.
- On PET tackboards, tack holes may remain visible after tacks have been removed.

Specify

Notes

- Fabric Selection

- Match each tackboard to it's specific hutch using height, width and style dimensions.
- Tackboard fabric direction is vertical on 24" to 48" wide units and will run horizontally for 54" to 96" wide pieces.

Tackboards for Spine Hutch D

PET TACKBOARD FOR SPINE HUTCH D

H	W	Model Number	List
20	36	C-CTACK2036D	366
20	42	C-CTACK2042D	397
20	48	C-CTACK2048D	412
20	54	C-CTACK2054D	427
20	60	C-CTACK2060D	458
20	66	C-CTACK2066D	472
20	72	C-CTACK2072D	504
20	78	C-CTACK2078D	518
20	84	C-CTACK2084D	534
28	36	C-CTACK2836D	412
28	42	C-CTACK2842D	442
28	48	C-CTACK2848D	458
28	54	C-CTACK2854D	488
28	60	C-CTACK2860D	518
28	66	C-CTACK2866D	549
28	72	C-CTACK2872D	565
28	78	C-CTACK2878D	595
28	84	C-CTACK2884D	625
36	36	C-CTACK3636D	458
36	42	C-CTACK3642D	488
36	48	C-CTACK3648D	518
36	54	C-CTACK3654D	549
36	60	C-CTACK3660D	579
36	66	C-CTACK3666D	610
36	72	C-CTACK3672D	640
36	78	C-CTACK3678D	671
36	84	C-CTACK3684D	701

FABRIC TACKBOARD FOR SPINE HUTCH D

H	W	Model Number	List	Fabric Grade C	Fabric Grade D
20	36	C-CTACKF2036D	623	+11	+23
20	42	C-CTACKF2042D	632	+11	+23
20	48	C-CTACKF2048D	647	+11	+23
20	54	C-CTACKF2054D	664	+11	+23
20	60	C-CTACKF2060D	679	+11	+23
20	66	C-CTACKF2066D	696	+11	+23
20	72	C-CTACKF2072D	714	+11	+23
20	78	C-CTACKF2078D	731	+11	+23
20	84	C-CTACKF2084D	749	+11	+23
28	36	C-CTACKF2836D	660	+17	+37
28	42	C-CTACKF2842D	671	+17	+37
28	48	C-CTACKF2848D	685	+17	+37
28	54	C-CTACKF2854D	697	+17	+37
28	60	C-CTACKF2860D	709	+17	+37
28	66	C-CTACKF2866D	793	+17	+37
28	72	C-CTACKF2872D	818	+17	+37
28	78	C-CTACKF2878D	843	+17	+37
28	84	C-CTACKF2884D	868	+17	+37
36	36	C-CTACKF3636D	697	+23	+50
36	42	C-CTACKF3642D	712	+23	+50
36	48	C-CTACKF3648D	728	+23	+50
36	54	C-CTACKF3654D	746	+23	+50
36	60	C-CTACKF3660D	760	+23	+50
36	66	C-CTACKF3666D	834	+23	+50
36	72	C-CTACKF3672D	861	+23	+50
36	78	C-CTACKF3678D	887	+23	+50
36	84	C-CTACKF3684D	914	+23	+50

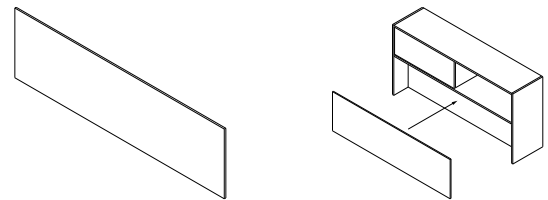
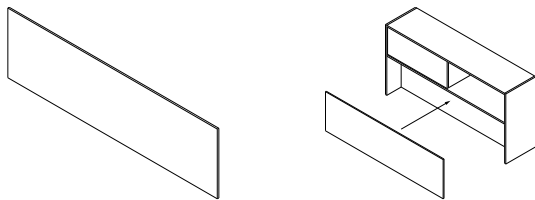

Specify • Color Selection for PET-Lite Grey, Medium Grey, Tan or Vibrant Blue

Notes • Match each tackboard to its specific hutch using height, width and style dimensions.
• On PET tackboards, tack holes may remain visible after tacks have been removed.

Specify • Fabric Selection

Notes • Match each tackboard to its specific hutch using height, width and style dimensions.
• Tackboard fabric direction is vertical on 24" to 48" wide units and will run horizontally for 54" to 96" wide pieces.

Tackboards for Spine Hutch E

PET TACKBOARD FOR SPINE HUTCH E

H	W	Model Number	List
28	36	C-CTACK2836E	412
28	42	C-CTACK2842E	442
28	48	C-CTACK2848E	458
28	54	C-CTACK2854E	488
28	60	C-CTACK2860E	518
28	66	C-CTACK2866E	549
28	72	C-CTACK2872E	565
28	78	C-CTACK2878E	595
28	84	C-CTACK2884E	625
36	36	C-CTACK3636E	458
36	42	C-CTACK3642E	488
36	48	C-CTACK3648E	518
36	54	C-CTACK3654E	549
36	60	C-CTACK3660E	579
36	66	C-CTACK3666E	610
36	72	C-CTACK3672E	640
36	78	C-CTACK3678E	671
36	84	C-CTACK3684E	701

FABRIC TACKBOARD FOR SPINE HUTCH E

H	W	Model Number	List	Fabric Grade C	Fabric Grade D
28	36	C-CTACKF2836E	660	+11	+23
28	42	C-CTACKF2842E	671	+11	+23
28	48	C-CTACKF2848E	685	+11	+23
28	54	C-CTACKF2854E	697	+11	+23
28	60	C-CTACKF2860E	709	+11	+23
28	66	C-CTACKF2866E	793	+11	+23
28	72	C-CTACKF2872E	818	+11	+23
28	78	C-CTACKF2878E	843	+11	+23
28	84	C-CTACKF2884E	868	+11	+23
36	36	C-CTACKF3636E	697	+23	+50
36	42	C-CTACKF3642E	712	+23	+50
36	48	C-CTACKF3648E	728	+23	+50
36	54	C-CTACKF3654E	746	+23	+50
36	60	C-CTACKF3660E	760	+23	+50
36	66	C-CTACKF3666E	834	+23	+50
36	72	C-CTACKF3672E	861	+23	+50
36	78	C-CTACKF3678E	887	+23	+50
36	84	C-CTACKF3684E	914	+23	+50

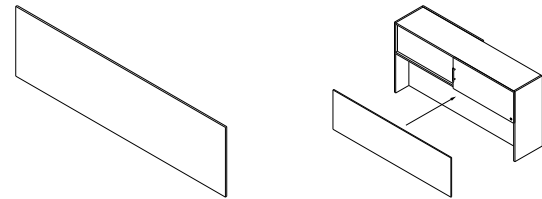
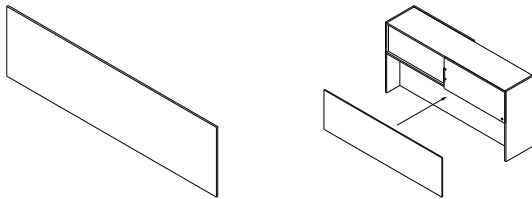

Specify **Notes**

- Color Selection for PET- Lite Grey, Medium Grey, Tan or Vibrant Blue
- Match each tackboard to it's specific hutch using height, width and style dimensions.
- On PET tackboards, tack holes may remain visible after tacks have been removed.

Specify **Notes**

- Fabric Selection
- Match each tackboard to it's specific hutch using height, width and style dimensions.
- Tackboard fabric direction is vertical on 24" to 48" wide units and will run horizontally for 54" to 96" wide pieces.

Tackboards for Spine Hutch G

PET TACKBOARD FOR SPINE HUTCH G

H	W	Model Number	List
20	24	C-CTACK2024G	320
20	30	C-CTACK2030G	351
20	36	C-CTACK2036G	366
20	42	C-CTACK2042G	397
20	48	C-CTACK2048G	412
20	54	C-CTACK2054G	427
20	60	C-CTACK2060G	458
20	66	C-CTACK2066G	472
20	72	C-CTACK2072G	504
20	78	C-CTACK2078G	518
20	84	C-CTACK2084G	534
28	24	C-CTACK2824G	351
28	30	C-CTACK2830G	381
28	36	C-CTACK2836G	412
28	42	C-CTACK2842G	442
28	48	C-CTACK2848G	458
28	54	C-CTACK2854G	488
28	60	C-CTACK2860G	518
28	66	C-CTACK2866G	549
28	72	C-CTACK2872G	565
28	78	C-CTACK2878G	595
28	84	C-CTACK2884G	625
36	24	C-CTACK3624G	381
36	30	C-CTACK3630G	427
36	36	C-CTACK3636G	458
36	42	C-CTACK3642G	488
36	48	C-CTACK3648G	518
36	54	C-CTACK3654G	549
36	60	C-CTACK3660G	579
36	66	C-CTACK3666G	610
36	72	C-CTACK3672G	640
36	78	C-CTACK3678G	671
36	84	C-CTACK3684G	701

FABRIC TACKBOARD FOR SPINE HUTCH G

H	W	Model Number	List	Fabric Grade C	Fabric Grade D
20	24	C-CTACKF2024G	604	+11	+23
20	30	C-CTACKF2030G	613	+11	+23
20	36	C-CTACKF2036G	623	+11	+23
20	42	C-CTACKF2042G	632	+11	+23
20	48	C-CTACKF2048G	647	+11	+23
20	54	C-CTACKF2054G	664	+11	+23
20	60	C-CTACKF2060G	679	+11	+23
20	66	C-CTACKF2066G	696	+11	+23
20	72	C-CTACKF2072G	714	+11	+23
20	78	C-CTACKF2078G	731	+11	+23
20	84	C-CTACKF2084G	749	+11	+23
28	24	C-CTACKF2824G	637	+23	+50
28	30	C-CTACKF2830G	648	+23	+50
28	36	C-CTACKF2836G	660	+23	+50
28	42	C-CTACKF2842G	671	+23	+50
28	48	C-CTACKF2848G	685	+23	+50
28	54	C-CTACKF2854G	697	+23	+50
28	60	C-CTACKF2860G	709	+23	+50
28	66	C-CTACKF2866G	793	+23	+50
28	72	C-CTACKF2872G	818	+23	+50
28	78	C-CTACKF2878G	843	+23	+50
28	84	C-CTACKF2884G	868	+23	+50
36	24	C-CTACKF3624G	668	+23	+50
36	30	C-CTACKF3630G	683	+23	+50
36	36	C-CTACKF3636G	697	+23	+50
36	42	C-CTACKF3642G	712	+23	+50
36	48	C-CTACKF3648G	728	+23	+50
36	54	C-CTACKF3654G	746	+23	+50
36	60	C-CTACKF3660G	760	+23	+50
36	66	C-CTACKF3666G	834	+23	+50
36	72	C-CTACKF3672G	861	+23	+50
36	78	C-CTACKF3678G	887	+23	+50
36	84	C-CTACKF3684G	914	+23	+50

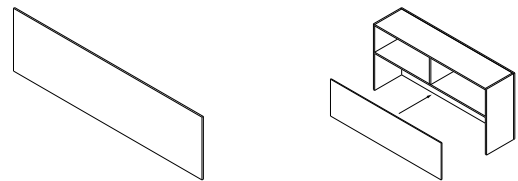
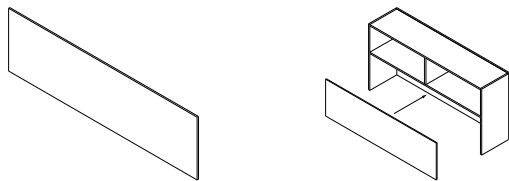

Specify • Color Selection for PET-Lite Grey, Medium Grey, Tan or Vibrant Blue

Notes • Match each tackboard to it's specific hutch using height, width and style dimensions.
• On PET tackboards, tack holes may remain visible after tacks have been removed.

Specify • Fabric Selection

Notes • Match each tackboard to it's specific hutch using height, width and style dimensions.
• Tackboard fabric direction is vertical on 24" to 48" wide units and will run horizontally for 54" to 96" wide pieces.

Tackboards for Spine Hutch H (Cantilevered)

PET TACKBOARD FOR SPINE HUTCH H (CANTILEVERED)

H	W	Model Number	List
20	60	C-CTACK2060H	458
20	66	C-CTACK2066H	472
20	72	C-CTACK2072H	504
20	78	C-CTACK2078H	518
20	84	C-CTACK2084H	534
28	60	C-CTACK2860H	518
28	66	C-CTACK2866H	549
28	72	C-CTACK2872H	565
28	78	C-CTACK2878H	595
28	84	C-CTACK2884H	625
36	60	C-CTACK3660H	579
36	66	C-CTACK3666H	610
36	72	C-CTACK3672H	640
36	78	C-CTACK3678H	671
36	84	C-CTACK3684H	701

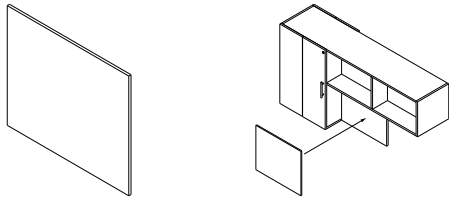

Specify • Color Selection for PET-Lite Grey, Medium Grey, Tan or Vibrant Blue

Notes • Match each tackboard to its specific hutch using height, width and style dimensions.
 • On PET tackboards, tack holes may remain visible after tacks have been removed.

FABRIC TACKBOARD FOR SPINE HUTCH H (CANTILEVERED)

H	W	Model Number	List	Fabric Grade C	Fabric Grade D
20	60	C-CTACKF2060H	679	+11	+23
20	66	C-CTACKF2066H	696	+11	+23
20	72	C-CTACKF2072H	714	+11	+23
20	78	C-CTACKF2078H	731	+11	+23
20	84	C-CTACKF2084H	749	+11	+23
28	60	C-CTACKF2860H	709	+23	+50
28	66	C-CTACKF2866H	793	+23	+50
28	72	C-CTACKF2872H	818	+23	+50
28	78	C-CTACKF2878H	843	+23	+50
28	84	C-CTACKF2884H	868	+23	+50
36	60	C-CTACKF3660H	760	+23	+50
36	66	C-CTACKF3666H	834	+23	+50
36	72	C-CTACKF3672H	861	+23	+50
36	78	C-CTACKF3678H	887	+23	+50
36	84	C-CTACKF3684H	914	+23	+50

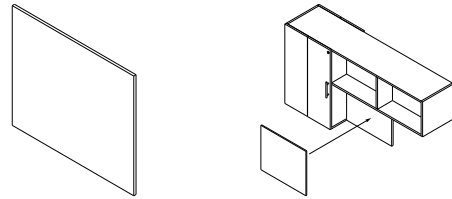

Specify • Fabric Selection

Notes • Match each tackboard to its specific hutch using height, width and style dimensions.
 • Tackboard fabric direction is vertical on 24" to 48" wide units and will run horizontally for 54" to 96" wide pieces.

Tackboards for Spine Hutch J

PET TACKBOARD FOR SPINE HUTCH J

H	W	Model Number	List
20	60	C-CTACK2060J	458
20	66	C-CTACK2066J	472
20	72	C-CTACK2072J	504
20	78	C-CTACK2078J	518
20	84	C-CTACK2084J	534
28	60	C-CTACK2860J	518
28	66	C-CTACK2866J	549
28	72	C-CTACK2872J	565
28	78	C-CTACK2878J	595
28	84	C-CTACK2884J	625
36	60	C-CTACK3660J	579
36	66	C-CTACK3666J	610
36	72	C-CTACK3672J	640
36	78	C-CTACK3678J	671
36	84	C-CTACK3684J	701

FABRIC TACKBOARD FOR SPINE HUTCH J

H	W	Model Number	List	Fabric Grade C	Fabric Grade D
20	60	C-CTACKF2060J	679	+11	+23
20	66	C-CTACKF2066J	696	+11	+23
20	72	C-CTACKF2072J	714	+11	+23
20	78	C-CTACKF2078J	731	+11	+23
20	84	C-CTACKF2084J	749	+11	+23
28	60	C-CTACKF2860J	709	+23	+50
28	66	C-CTACKF2866J	793	+23	+50
28	72	C-CTACKF2872J	818	+23	+50
28	78	C-CTACKF2878J	843	+23	+50
28	84	C-CTACKF2884J	868	+23	+50
36	60	C-CTACKF3660J	760	+23	+50
36	66	C-CTACKF3666J	834	+23	+50
36	72	C-CTACKF3672J	861	+23	+50
36	78	C-CTACKF3678J	887	+23	+50
36	84	C-CTACKF3684J	914	+23	+50

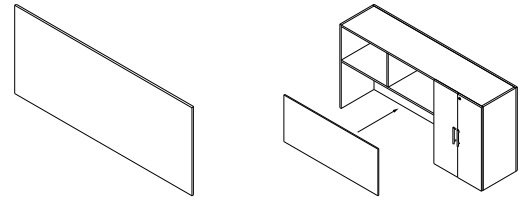
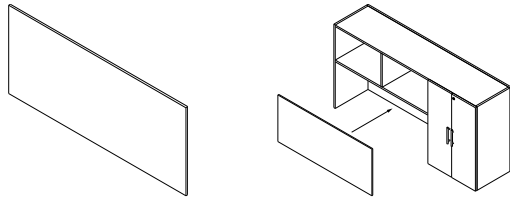

Specify **Notes**

- Color Selection for PET- Lite Grey, Medium Grey, Tan or Vibrant Blue
- Match each tackboard to it's specific hutch using height, width and style dimensions.
- On PET tackboards, tack holes may remain visible after tacks have been removed.

Specify **Notes**

- Fabric Selection
- Match each tackboard to it's specific hutch using height, width and style dimensions.
- Tackboard fabric direction is vertical on 24" to 48" wide units and will run horizontally for 54" to 96" wide pieces.

Tackboards for Spine Hutch K

PET TACKBOARD FOR SPINE HUTCH K

H	W	Model Number	List
28	36	C-CTACK2836K	412
28	42	C-CTACK2842K	442
28	48	C-CTACK2848K	458
28	54	C-CTACK2854K	488
28	60	C-CTACK2860K	518
28	66	C-CTACK2866K	549
28	72	C-CTACK2872K	565
28	78	C-CTACK2878K	595
28	84	C-CTACK2884K	625
36	36	C-CTACK3636K	458
36	42	C-CTACK3642K	488
36	48	C-CTACK3648K	518
36	54	C-CTACK3654K	549
36	60	C-CTACK3660K	579
36	66	C-CTACK3666K	610
36	72	C-CTACK3672K	640
36	78	C-CTACK3678K	671
36	84	C-CTACK3684K	701

FABRIC TACKBOARD FOR SPINE HUTCH K

H	W	Model Number	List	Fabric Grade C	Fabric Grade D
28	36	C-CTACKF2836K	660	+17	+37
28	42	C-CTACKF2842K	671	+17	+37
28	48	C-CTACKF2848K	685	+17	+37
28	54	C-CTACKF2854K	697	+17	+37
28	60	C-CTACKF2860K	709	+17	+37
28	66	C-CTACKF2866K	793	+17	+37
28	72	C-CTACKF2872K	818	+17	+37
28	78	C-CTACKF2878K	843	+17	+37
28	84	C-CTACKF2884K	868	+17	+37
36	36	C-CTACKF3636K	697	+23	+50
36	42	C-CTACKF3642K	712	+23	+50
36	48	C-CTACKF3648K	728	+23	+50
36	54	C-CTACKF3654K	746	+23	+50
36	60	C-CTACKF3660K	760	+23	+50
36	66	C-CTACKF3666K	834	+23	+50
36	72	C-CTACKF3672K	861	+23	+50
36	78	C-CTACKF3678K	887	+23	+50
36	84	C-CTACKF3684K	914	+23	+50

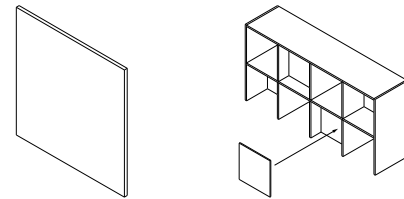
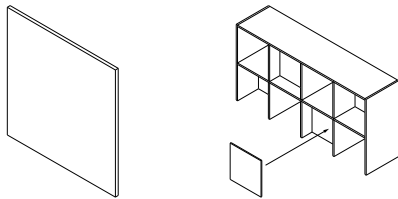

Specify **Notes**

- Color Selection for PET- Lite Grey, Medium Grey, Tan or Vibrant Blue
- Match each tackboard to it's specific hutch using height, width and style dimensions.
- Each tackboard is sold individually (not as a set).
- On PET tackboards, tack holes may remain visible after tacks have been removed.

Specify **Notes**

- Fabric Selection
- Match each tackboard to it's specific hutch using height, width and style dimensions.
- Tackboard fabric direction is vertical on 24" to 48" wide units and will run horizontally for 54" to 96" wide pieces.



National Showrooms:

Leominster

AIS Headquarters
25 Tucker Drive
Leominster, MA 01453

Chicago

The Merchandise Mart
Suite 1086
Chicago, Illinois 60654

New York

AIS New York
257 Park Avenue South
New York, New York 10010

Washington, D.C.

AIS Washington, D.C.
1400 I St, NW, Suite 750
Washington, D.C. 20005

GSA Sales

GSA Contract 47QSM20D08Q4
Multiple Award Schedule (MAS)
Large Category: Furniture & Furnishings
Subcategories: Office Furniture, Packaged
Office Furniture and Furniture Services

For additional information on AIS:

Dealer Showrooms, Representative
Directory, Project Case Studies, Online
Catalog & Product Showcase
Visit: www.ais-inc.com